

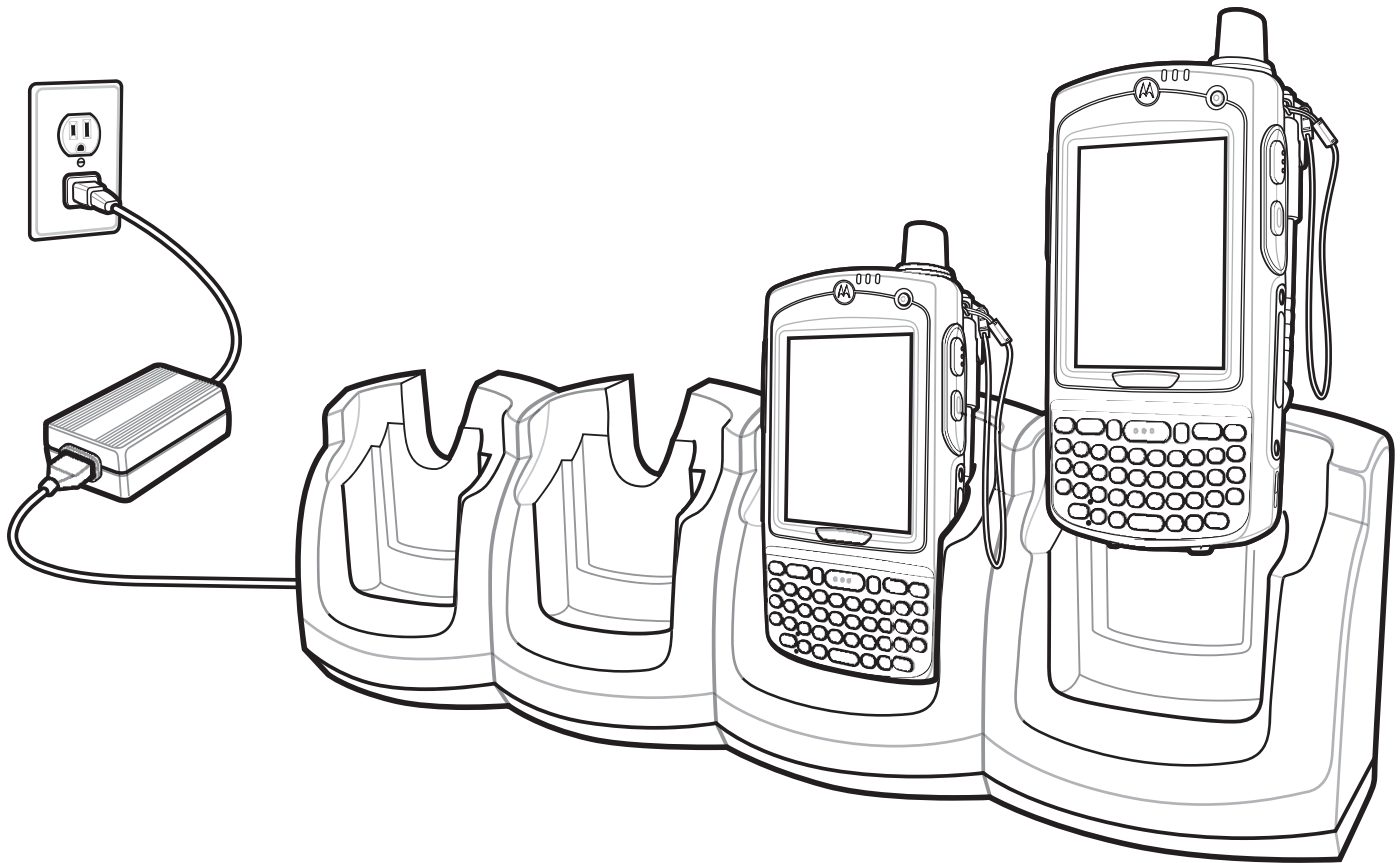

MC75 Enterprise Digital Assistant Integrator Guide



***MC75 Enterprise Digital Assistant
Integrator Guide***

72E-103078-03

Rev. A

March 2010

© 2008-10 by Motorola, Inc. All rights reserved.

No part of this publication may be reproduced or used in any form, or by any electrical or mechanical means, without permission in writing from Motorola. This includes electronic or mechanical means, such as photocopying, recording, or information storage and retrieval systems. The material in this manual is subject to change without notice.

The software is provided strictly on an “as is” basis. All software, including firmware, furnished to the user is on a licensed basis. Motorola grants to the user a non-transferable and non-exclusive license to use each software or firmware program delivered hereunder (licensed program). Except as noted below, such license may not be assigned, sublicensed, or otherwise transferred by the user without prior written consent of Motorola. No right to copy a licensed program in whole or in part is granted, except as permitted under copyright law. The user shall not modify, merge, or incorporate any form or portion of a licensed program with other program material, create a derivative work from a licensed program, or use a licensed program in a network without written permission from Motorola. The user agrees to maintain Motorola’s copyright notice on the licensed programs delivered hereunder, and to include the same on any authorized copies it makes, in whole or in part. The user agrees not to decompile, disassemble, decode, or reverse engineer any licensed program delivered to the user or any portion thereof.

Motorola reserves the right to make changes to any software or product to improve reliability, function, or design.

Motorola does not assume any product liability arising out of, or in connection with, the application or use of any product, circuit, or application described herein.

No license is granted, either expressly or by implication, estoppel, or otherwise under any Motorola, Inc., intellectual property rights. An implied license only exists for equipment, circuits, and subsystems contained in Motorola products.

MOTOROLA and the Stylized M Logo and Symbol and the Symbol logo are registered in the US Patent & Trademark Office. Bluetooth is a registered trademark of Bluetooth SIG. Microsoft, Windows and ActiveSync are either registered trademarks or trademarks of Microsoft Corporation. All other product or service names are the property of their respective owners.

Motorola, Inc.
One Motorola Plaza
Holtsville, New York 11742-1300
<http://www.motorola.com/enterprisemobility>

Patents

This product is covered by one or more of the patents listed on the website: <http://www.motorola.com/enterprisemobility/patents>.

Revision History

Changes to the original manual are listed below:

Change	Date	Description
-01 Rev. A	06/13/08	Initial Release.
-02 Rev. A	12/15/08	Add re-boot after installing SIM card. Correct MC75 COM Port Definitions.
-03 Rev. A	02/15/10	Add support for OEM versions 02.35.000 and 02.35.001. Correct cold boot process. Add DCR7X00-200R accessory.

Table of Contents

Patents.....	ii
Revision History.....	iii

About This Guide

Introduction.....	xiii
Documentation Set.....	xiii
Configurations.....	xiv
Software Versions.....	xiv
Chapter Descriptions.....	xvii
Notational Conventions.....	xvii
Related Documents and Software.....	xviii
Service Information.....	xviii

Chapter 1: Getting Started

Introduction.....	1-1
Unpacking the MC75.....	1-1
Accessories.....	1-2
Getting Started.....	1-3
Installing the SIM Card.....	1-4
Installing the Main Battery.....	1-5
Charging the Battery.....	1-6
Charging the Main Battery and Memory Backup Battery.....	1-6
Charging Spare Batteries.....	1-7
Charging Temperature.....	1-7
Powering On the MC75.....	1-8
Calibrating the Screen.....	1-8
Checking Battery Status.....	1-8
Resetting the MC75.....	1-8
Performing a Warm Boot.....	1-8
Performing a Cold Boot.....	1-8
Performing a Clean Boot.....	1-9
Waking the MC75.....	1-9

Locking the MC75	1-10
Micro Secure Digital (microSD) Card	1-10
Removing the Screen Protector	1-11
Replacing the Main Battery	1-12

Chapter 2: Accessories

Introduction	2-1
Single Slot USB/Serial Cradle	2-2
Setup	2-2
Charging the MC75 Battery	2-2
Charging the Spare Battery	2-3
Battery Charging Indicators	2-3
Charging Temperature	2-4
Four Slot Ethernet Cradle	2-5
Setup	2-5
Daisy chaining Ethernet Cradles	2-5
Bandwidth Considerations when Daisy chaining	2-6
Ethernet Cradle Drivers	2-6
Charging and Communication	2-8
LED Charging Indicators	2-9
Charge LED	2-9
Speed LED	2-9
Link LED	2-9
Charging Temperature	2-9
Four Slot Charge Only Cradle	2-10
Setup	2-10
Charging Temperature	2-10
Wall Mount Bracket	2-11
VCD7X00 Vehicle Cradle	2-13
Requirements	2-13
Connector Ports	2-13
Connector Pin-Outs	2-14
Mounting the Cradle	2-14
Power Connection	2-15
Serial Device Connection	2-17
Charging the MC75 Battery	2-17
Removing the MC75	2-18
Charging the Spare Battery	2-18
Battery Charging Indicators	2-19
Charging Temperature	2-20
Four Slot Battery Charger	2-21
Battery Shim Installation	2-21
Spare Battery Charging	2-21
Battery Charging Indicators	2-22
Charging Temperature	2-22
Magnetic Stripe Reader (MSR)	2-23
Attaching and Removing the MSR	2-23
Using the MSR	2-23
Debit Card Reader	2-25

Getting Started	2-25
Installation	2-25
Removal	2-25
Credit Card Transactions	2-26
Debit Card Transactions	2-26
Keypad	2-27
Display Messages	2-28
Check the DCR Battery Level	2-28
Charging the MC75	2-29
Key Injection	2-29
Maintenance	2-29
Snap-on Mobile Payment Module with Chip and PIN	2-30
Installation	2-30
Removal	2-30
Credit Card Transactions	2-31
Debit Card Transactions	2-31
Chip and PIN Transactions	2-32
Keypad	2-32
Display Messages	2-33
Headset	2-34
Cables	2-36
Setup	2-36
Battery Charging	2-37
LED Charge Indications	2-37
Charging Temperature	2-37
Communication Setup	2-37

Chapter 3: ActiveSync

Introduction	3-1
Installing ActiveSync	3-1
Mobile Computer Setup	3-2
USB Configuration	3-2
Setting Up an ActiveSync Connection on the Host Computer	3-3
Synchronization with a Windows Mobile 6 Device	3-4

Chapter 4: Application Deployment for Mobile 6

Introduction	4-1
Security	4-1
Application Security	4-1
Digital Signatures	4-1
Locking Down a Mobile Computer	4-2
Installing Certificates	4-3
Device Management Security	4-3
Remote API Security	4-3
Packaging	4-4
Deployment	4-4
Installation Using ActiveSync	4-4
Installation Using Storage Card	4-4

Installation Using AirBEAM	4-5
MSP 3.X	4-5
Image Update	4-5
Creating a Splash Screen	4-6
XML Provisioning	4-6
Creating an XML Provisioning File	4-7
XML Provisioning vs. RegMerge and Copy File	4-7
RegMerge	4-7
CopyFiles	4-8
Storage	4-8
Random Access Memory	4-9
Volatile File Storage (Cache Disk)	4-9
Persistent Storage	4-9
Application Folder	4-9
Symbol Configuration Manager	4-9
File Types	4-10
User Interface	4-10
Menu Functions	4-10
Parameter State Indicators	4-11
Window Status Bar	4-11
File Deployment	4-12
Enterprise Mobility Developer Kits	4-12

Chapter 5: MC7506/96 - GSM Configuration

Introduction	5-1
Quick Startup Steps	5-1
MC7506/96 Service Verification	5-3
Ensuring Network Coverage	5-3
Configuring a Data Connection	5-4
Establishing a Data Connection	5-5
Ending a Data Connection	5-7
MC7506/96 Settings	5-8
Phone	5-8
Sounds	5-8
Security	5-9
Services	5-10
Call Barring (Call Blocking)	5-10
Caller ID	5-11
Call Forwarding	5-11
Call Waiting	5-12
Voice Mail and Text Messages	5-12
Fixed Dialing	5-13
Network	5-13
Changing Networks Manually	5-14
Viewing Available Networks	5-14
Setting Preferred Networks	5-15
Phone Info	5-16
Network Time Synchronization	5-17
Enhanced Operator Name String	5-17

Service Provider Name Display	5-17
-------------------------------------	------

Chapter 6: MC7508/98 - CDMA Configuration

Introduction	6-1
Quick Startup Steps	6-1
CDMA Phone Activation	6-2
Verizon Wireless Activation	6-2
Sprint Activation	6-3
Manual Activation	6-3
Activation Test	6-5
Establishing a Data Connection	6-6
CDMA Settings	6-7
Phone	6-7
Location Settings	6-8
Data Settings	6-8
Sprint Data Settings	6-8
Verizon Wireless Data Settings	6-10
Additional Service provider Data Settings	6-10
System Settings	6-11
Sprint System	6-11
Verizon System	6-12
Additional Service Provider System	6-13
Version Information	6-13
Services	6-14
Call Barring (Call Blocking)	6-14
Caller ID	6-14
Call Forwarding	6-14
Call Waiting	6-15
Voice Mail and Short Message Service (SMS)	6-15
Network Time Synchronization	6-15

Chapter 7: Wireless Applications

Introduction	7-1
Signal Strength Icon	7-2
Turning the WLAN Radio On and Off	7-3

Chapter 8: Maintenance and Troubleshooting

Introduction	8-1
Maintaining the MC75	8-1
Battery Safety Guidelines	8-2
Cleaning	8-3
Materials Required	8-3
Cleaning the MC75	8-3
Housing	8-3
Display	8-3
Scanner Exit Window	8-3
Connector	8-3

Cleaning Cradle Connectors	8-4
Cleaning Frequency	8-4
Troubleshooting	8-5
MC75	8-5
Bluetooth Connection	8-7
Single Slot USB/Serial Cradle	8-8
Four Slot Ethernet Cradle	8-9
Vehicle Cradle	8-9
Four Slot Spare Battery Charger	8-10
Cables	8-10
Magnetic Stripe Reader	8-11

Appendix A: Technical Specifications

Technical Specifications	A-1
MC75	A-1
MC75 COM Port Definitions	A-4
MC75 Pin-Outs	A-5
MC75 Accessory Specifications	A-6
Single Slot USB/Serial Cradle	A-6
Four Slot Ethernet Cradle	A-6
Four Slot Charge Only Cradle	A-7
Four Slot Battery Charger	A-7
Magnetic Stripe Reader	A-8
Vehicle Cradle	A-9

Appendix B: Bluetooth Configuration

Glossary

Index

About This Guide

Introduction

This *Integrator Guide* provides information about setting up and configuring MC75 and accessories.

✓ **NOTE** Screens and windows pictured in this guide are samples and can differ from actual screens.

Documentation Set

The documentation for the MC75 is divided into guides that provide information for specific user needs.

- **MC75 Quick Start Guide** - describes how to get the MC75 up and running.
- **MC75 User Guide** - describes how to use the MC75.
- **MC75 Integrator Guide** - describes how to set up the MC75 and accessories.
- **Windows Mobile® 6 Applications User Guide for Enterprise Mobility Devices** - describes how to use Microsoft developed applications.
- **Enterprise Mobility Application Guide** - describes how to use Enterprise Mobility developed sample applications.
- **Enterprise Mobility Developer Kit (EMDK) Help File** - provides API information for writing applications.

Configurations

This guide covers the following configurations:

Configuration	Radios	Display	Memory	Data Capture	Operating System	Keypads
MC7506	WPAN: Bluetooth WWAN: HSDPA GPS	3.5"VGA Color	128 MB RAM/ 256 MB Flash	1D laser scanner, 2D imager	Windows Mobile 6.1 Professional	Numeric, AZERTY, QWERTY or QWERTZ
MC7508	WPAN: Bluetooth WWAN: EVDO GPS	3.5"VGA Color	128 MB RAM/ 256 MB Flash	1D laser scanner, 2D imager	Windows Mobile 6.1 Professional	Numeric, AZERTY, QWERTY or QWERTZ
MC7596	WLAN: 802.11a/b/g WPAN: Bluetooth WWAN: HSDPA GPS	3.5"VGA Color	128 MB RAM/ 256 MB Flash or 128 MB RAM/512 MB Flash	1D laser scanner, 2D imager 1D laser scanner with 2MP camera, 2D imager with 2MP camera	Windows Mobile 6.1 Professional	Numeric, DSD, AZERTY, QWERTY or QWERTZ
MC7598	WLAN: 802.11a/b/g WPAN: Bluetooth WWAN: EVDO GPS	3.5"VGA Color	128 MB RAM/ 256 MB Flash or 128 MB RAM/512 MB Flash	1D laser scanner, 2D imager, 1D laser scanner with 2MP camera, 2D imager with 2MP camera	Windows Mobile 6.1 Professional	Numeric, AZERTY, QWERTY or QWERTZ

Software Versions

This guide covers various software configurations and references are made to operating system or software versions for:

- Adaptation Kit Update (AKU) version
- OEM version
- Phone version
- BTEplorer version
- Fusion version
- Phone version.

AKU Version

To determine the Adaptation Kit Update (AKU) version:

Tap **Start > Settings > System tab > About icon > Version tab.**

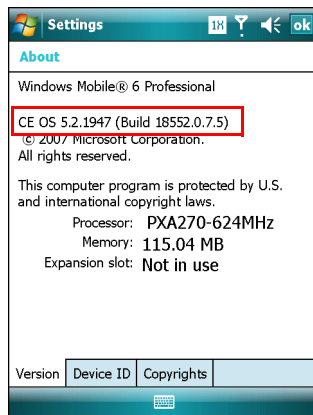

The second line lists the operating system version and the build number. The last part of the build number represents the AKU number. For example, *Build 18165.0.5.0* indicates that the device is running AKU version *0.5.0*.

OEM Version

To determine the OEM software version:

Tap **Start > Settings > System tab > System Information icon > System tab**.

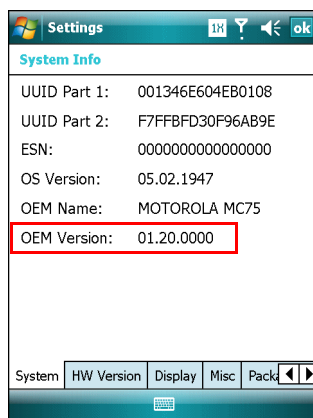

BTEplorer Software

To determine the BTEplorer software version:

- Tap **BTEplorer icon > Show BTEplorer**.
- If the New Connection window appears, tap **Cancel**.
- Tap **Menu > About**.

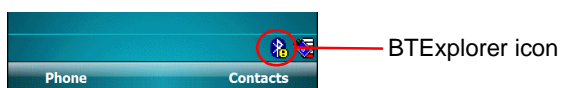



Fusion Software

To determine the Fusion software version:

Tap **Signal Strength** icon > **Wireless Status** > **Versions**.

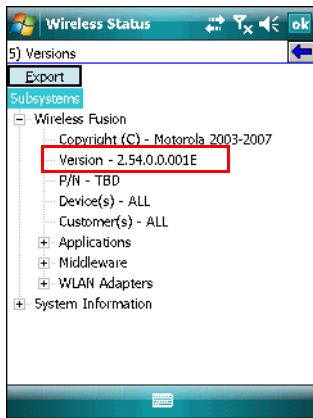

Phone Software

To determine the Phone software version:

Tap **Start** > **Phone** > **Menu** > **Options** > **Version Information** tab.

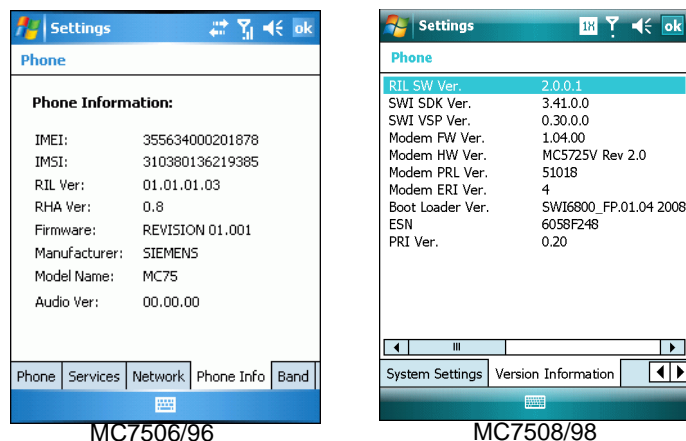

Chapter Descriptions

Topics covered in this guide are as follows:

- [Chapter 1, Getting Started](#) provides information on MC75 configurations and accessories, charging the battery, and resetting.
- [Chapter 2, Accessories](#) describes the accessories available for the MC75 and how to set up power connections and battery charging capabilities, where applicable.
- [Chapter 3, ActiveSync](#) provides instructions on installing ActiveSync and setting up a partnership between the MC75 and a host computer.
- [Chapter 4, Application Deployment for Mobile 6](#) provides information for provisioning and deploying applications to the MC75.
- [Chapter 5, MC7506/96 - GSM Configuration](#) explains how to verify MC7506/96 service on an Enhanced Data rates for Global Evolution (EDGE) wireless network and establish settings.
- [Chapter 6, MC7508/98 - CDMA Configuration](#) explains how to configure MC7508/98 service on an CDMA wireless network and establish settings.
- [Chapter 7, Wireless Applications](#) describes how to configure the wireless LAN connection.
- [Chapter 8, Maintenance and Troubleshooting](#) includes instructions on cleaning and storing the MC75, and provides troubleshooting solutions for potential problems during MC75 operation.
- [Appendix A, Technical Specifications](#) includes tables listing the technical specifications for the MC75 and its accessories.
- [Appendix B, Bluetooth Configuration](#) provides registry settings required for configuring the use of the Bluetooth stack.

Notational Conventions

The following conventions are used in this document:

- “MC75” refers to all configurations of the MC75XX mobile computer.

- *Italics* are used to highlight the following:
 - chapters and sections in this and related documents
 - dialog box, window, and screen names
 - drop-down list and list box names
 - check box and radio button names
 - icons on a screen.
- **Bold** text is used to highlight the following:
 - key names on a keypad
 - button names on a screen.
- Bullets (•) indicate:
 - action items
 - lists of alternatives
 - lists of required steps that are not necessarily sequential.
- Sequential lists (e.g., those that describe step-by-step procedures) appear as numbered lists.

Related Documents and Software

The following documents provide more information about the MC75.

- *MC75 Quick Start Guide*, p/n 72-103079-xx
- *MC75 Windows Mobile 6 Regulatory Guide*, p/n 72-103080-xx
- *MC75 User Guide*, p/n 72E-103077-xx
- *Microsoft® Applications for Mobile and CE 6 User Guide*, p/n 72E-108299-01-xx
- *Symbol Application Guide*, p/n 72E-68901-xx
- *Enterprise Mobility Developer Kits (EMDKs)*, available at: <http://www.motorola.com/enterprisemobility/support>.
- Latest ActiveSync software, available at: <http://www.microsoft.com>.

For the latest version of this guide and all guides, go to: <http://www.motorola.com/enterprisemobility/manuals>.

Service Information

If you have a problem with your equipment, contact Motorola Enterprise Mobility support for your region. Contact information is available at: <http://www.motorola.com/enterprisemobility/contactsupport>.

When contacting Enterprise Mobility support, please have the following information available:

- Serial number of the unit
- Model number or product name
- Software type and version number

Motorola responds to calls by e-mail, telephone or fax within the time limits set forth in support agreements.

If your problem cannot be solved by Motorola Enterprise Mobility Support, you may need to return your equipment for servicing and will be given specific directions. Motorola is not responsible for any damages incurred during shipment if the approved shipping container is not used. Shipping the units improperly can possibly void the warranty.

If you purchased your Enterprise Mobility business product from a Motorola business partner, contact that business partner for support.

Chapter 1 Getting Started

Introduction

This chapter provides information about the MC75, accessories, charging the MC75, and resetting the MC75.

Unpacking the MC75

Carefully remove all protective material from the MC75 and save the shipping container for later storage and shipping. Verify that you received the following equipment:

- MC75
- Lithium-ion battery
- Battery cover/strap assembly
- Tethered stylus
- Protective overlay, installed on display window
- Regulatory Guide
- Quick Start Guide.

Inspect the equipment. If any equipment is missing or damaged, contact the Motorola Enterprise Mobility support immediately. See [Service Information on page xviii](#) for contact information.

Accessories

Table 1-1 lists the accessories available for the MC75.

Table 1-1 MC75 Accessories

Accessory	Part Number	Description
Cradles		
Single Slot USB/Serial Cradle	CRD7X00-1000RR	Charges the MC75 main battery and a spare battery. Synchronizes the MC75 with a host computer through either a serial or a USB connection.
Four Slot Ethernet Cradle	CRD7000-4000ER	Charges the MC75 main battery and connects the MC75 with an Ethernet network.
Four Slot Charge Only Cradle	CRD7X00-4000CR	Charges up to four MC75 devices.
VCD7000 Vehicle Cradle	VCD7X00-P000R	Installs in a vehicle and charges the MC75 main battery and a spare battery. Provides serial data communication between an MC75 and an external device.
Chargers		
Four Slot Spare Battery Charger	SAC7X00-4000CR	Charges up to four MC75 spare batteries. Includes an MC75 shim.
Serial Charging Cable	25-102776-01R	Provides power to the MC75 and serial communication with a host computer.
USB Charging Cable	25-102775-01R	Provides power to the MC75 and USB communication with a host computer.
Charge Only Cable	25-95214-02R	Provides power to the MC75.
Auto Charge Cable	25-70979-02R	Charges the MC75 using a vehicle's cigarette lighter.
Cables		
DEX Cable	25-76793-01R	Connects the MC75 to a vending machine.
Modem Dongle	MDM9000-100R	Provides modem connectivity to the MC75.
Modem Inverter Cables	25-70924-03R	Connects the MC75 to the modem dongle.
O'Neil Printer Cable	25-91519-01R	Printer cable for O'Neil printers.
Zebra Printer Cable	25-91518-01R	Printer cable Zebra Road Warrior printers.
Zebra Printer Cable	25-91515-01R	Printer cable for Zebra QL printers.
Miscellaneous		
Magnetic Stripe Reader (MSR)	MSR7000-100R	Snaps on to the MC75 and adds magstripe read capabilities.

Table 1-1 MC75 Accessories (Continued)

Accessory	Part Number	Description
Debit Card Reader	DCR7X00-100R	Allows easy data capture with the swipe of a magnetic stripe card and personal identification number (PIN) entry using a numeric keypad.
Snap-on Mobile Payment Module with Chip and PIN	DCR7X00-200R	Allows easy data capture with magnetic stripe cards, EMV compliant Chip and PIN cards and personal identification number (PIN) entry using a numeric keypad.
Biometric Attachment	MC7XFPR-01R	Contains a finger print reader.
Biometric Attachment	MC7XFPSCR-01R	Contains a finger print reader, a contact smart card reader and a contactless smart card reader.
Spare 3600 mAh lithium-ion battery	BTRY-MC7XEAB00	Replacement 3600 mAh battery.
Spare 4800 mAh lithium-ion battery	BTRY-MC7XEAB0H	Optional 4800 mAh battery.
Battery Kit for 3600 mAh battery	BTRY-KT-1R5X-MC7XR	Replacement 3600 mAh battery and battery door.
Battery Kit for 4800 mAh battery	BTRY-KT-2R5X-MC7XR	Replacement 4800 mAh battery and battery door.
Headset	50-11300-050R	Use in noisy environments.
Belt Mounted Rigid Holster	SG-MC70011110-01R	Clips onto belt to hold the MC75 when not in use.
Fabric Holster	SG-MC7521215-01R	Soft holder for added protection.
Stylus	Stylus-00002-03R	Replacement stylus (3-pack).
Wall Mounting Kit	8710-050006-01R	Use for wall mounting the four slot cradles.
Screen Protector	KT-67525-01R	Package of 3 screen protectors.
Software	-	<i>Enterprise Mobility Developer Kits (EMDKs)</i> , available at: http://www.motorola.com/enterprisemobility/support .

Getting Started

To start using the MC75 for the first time:

- Install the SIM card (MC7506 and MC7596 only).
- Install the main battery and cover assembly.
- Charge the MC75.
- Power on the MC75.
- Configure the MC75.

Charge the main battery before or after it is installed. Use one of the spare battery chargers to charge the battery (out of the MC75), or one of the cradles to charge the battery installed in the MC75.

Installing the SIM Card

- ✓ **NOTE** MC7506 and MC7596 configurations only.

GSM phone service requires a Subscriber Identification Module (SIM) card, or smart card. Obtain this card from the phone service provider. The card fits into the MC75 and can contain the following information:

- Mobile phone service provider account details.
- Information regarding service access and preferences.
- Contact information, which can be moved to Contacts on the MC75.
- Any additional services to which you have subscribed.

- ✓ **NOTE** For more information about SIM cards, refer to the mobile phone service provider's documentation.

To install the SIM card:

1. Press the red **Power** button to suspend the MC75.
2. Remove the battery cover and the battery.
3. Lift the SIM cover using the stylus tip.

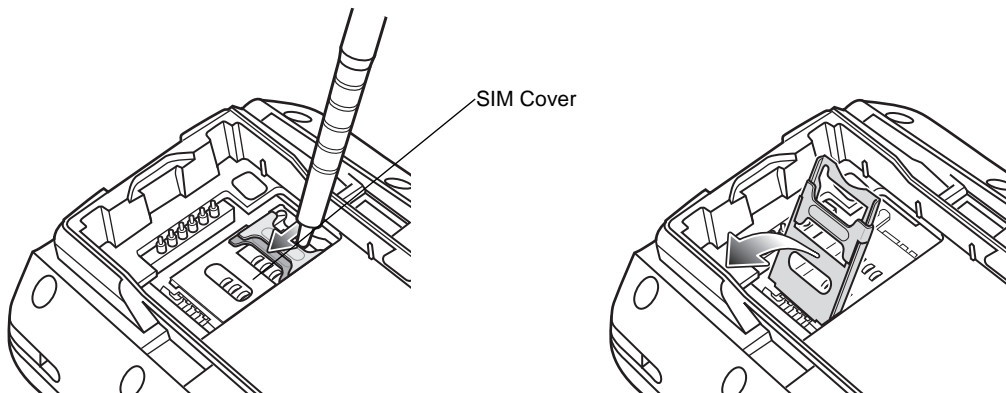

Figure 1-1 Lifting the SIM Cover

4. Insert the SIM card, as shown in [Figure 1-2](#), with the cut edge of the card facing out and the contacts facing down.

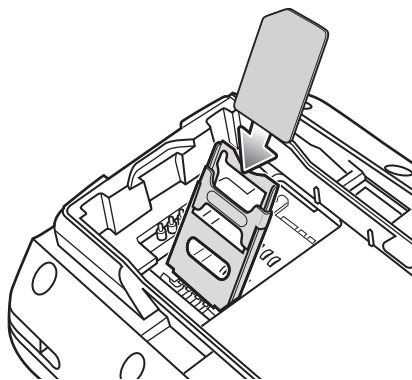

Figure 1-2 Inserting the SIM Card

5. Lower the SIM cover and using the stylus slide it in place.
6. Install the battery. See [Installing the Main Battery on page 1-5](#) for more information.
7. After completing initial MC75 setup or after replacing a SIM card:
 - a. Press the red Power button.
 - b. On the Today screen, tap **Wireless Manager**.
 - c. Ensure Phone is on.
 - d. Press the red Power button to suspend the MC75.
 - e. Perform a warm boot. See [Performing a Warm Boot on page 1-8](#).
 - f. Make a call to verify cellular connection.

✓ **NOTE** For detailed information about WWAN activation and settings, refer to [Chapter 2, Accessories](#).

Installing the Main Battery

✓ **NOTE** The MC75 ships with a 3600 mAh battery. An optional 4800 mAh battery is available.

To install the main battery.

1. Insert the battery, top first, into the battery compartment in the back of the MC75.

✓ **NOTE** Position the battery correctly, with the battery charging contacts on top of the charging contacts in the battery compartment.

2. Press the battery down into the battery compartment until the battery release latch snaps into place.

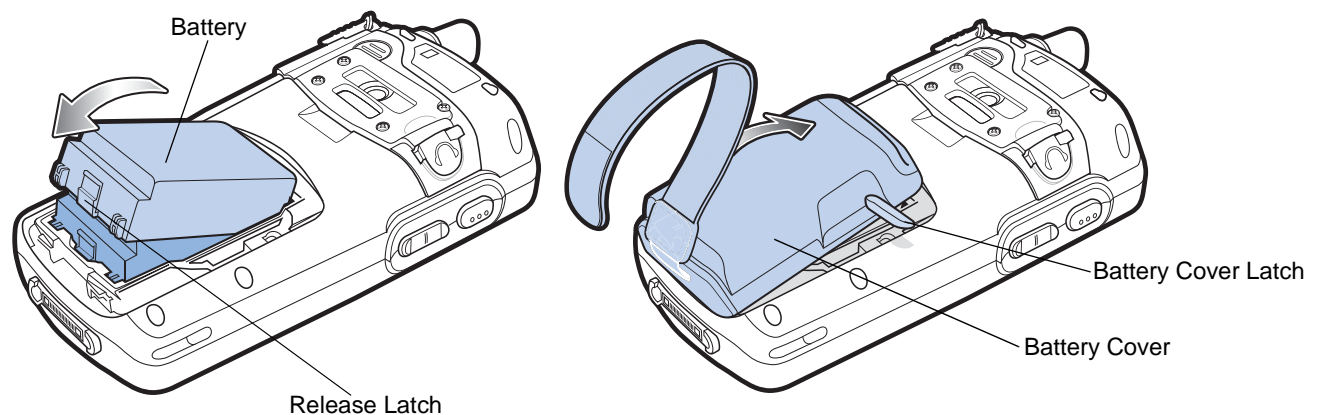

Figure 1-3 *Inserting the Battery*

3. With the battery cover latches open, insert the cover, bottom first, then press down on the top of the cover.
4. Close the battery cover latches on either side of the battery cover.
5. Insert the handstrap through the handstrap slot, then tighten and press down to secure.

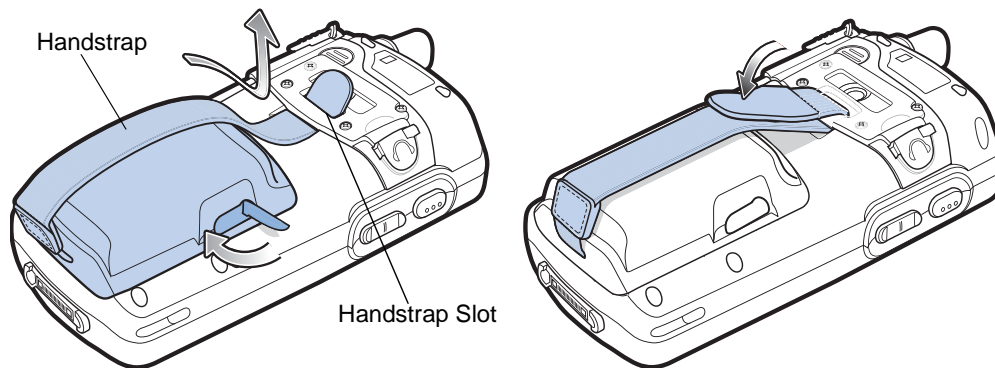

Figure 1-4 Inserting the Handstrap

The MC75 powers up after inserting the battery and replacing the battery cover.

Charging the Battery



CAUTION Ensure that you follow the guidelines for battery safety described in [Battery Safety Guidelines on page 8-2](#).

Charging the Main Battery and Memory Backup Battery

Before using the MC75 for the first time, charge the main battery until the amber Charging/Battery Status LED remains lit (see [Table 1-2 on page 1-7](#) for charge status indications). To charge the MC75, use a cable or a cradle with the appropriate power supply. For information about the accessories available for the MC75, see [Chapter 2, Accessories](#).

The MC75 is equipped with a memory backup battery which automatically charges from the fully-charged main battery. When using the MC75 for the first time, the backup battery requires approximately 36 hours to fully charge. This is also true any time the backup battery is discharged, which occurs when the main battery is removed for several hours. The backup battery retains RAM data in memory for at least 15 minutes (at room temperature) when the MC75's main battery is removed. When the MC75 reaches a very low battery state, the combination of main battery and backup battery retains RAM data in memory for at least 48 hours.

To charge the main battery, use either a charging cable or a cradle. For cable and cradle setup and charging procedures see [Chapter 2, Accessories](#).

- Single Slot USB/Serial Cradle
- Four Slot Ethernet Cradle
- Four Slot Charge Only Cradle
- Vehicle Cradle.

To charge the main battery:

1. Connect the charging accessory to the appropriate power source.
2. Insert the MC75 into a cradle or attach to a cable. The MC75 begins charging. The Charging/Battery Status LED blinks amber while charging, then turns solid amber when fully charged. See [Table 1-2](#) for charging indications.

The 3600 mAh battery fully charges in approximately five hours and the 4800 mAh battery charges in approximately seven hours.

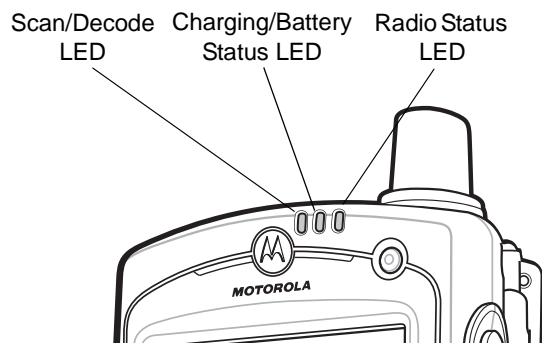

Figure 1-5 LED Indicators

Table 1-2 LED Charge Indicators

Charging/Battery Status LED	Indication
Off	MC75 is not charging. MC75 is not inserted correctly in the cradle or connected to a power source. Charger/cradle is not powered.
Slow Blinking Amber (1 blink every 2 seconds)	MC75 is charging.
Solid Amber	Charging complete. Note: When the battery is initially inserted in the MC75, the amber LED flashes once if the battery power is low or the battery is not fully inserted.
Fast Blinking Amber (2 blinks/second)	Charging error, e.g.: <ul style="list-style-type: none"> • Temperature is too low or too high. • Charging has gone on too long without completion (typically eight hours).
Single Blink Amber (when Power button pressed)	Battery depleted.
Blinking Amber (when Power button pressed)	Battery over-temperature condition.

Charging Spare Batteries

See [Chapter 2, Accessories](#) for information on using accessories to change spare batteries.

Charging Temperature

Charge batteries in temperatures from 0°C to 40°C (32°F to 104°F). Note that at temperatures above 35°C (95°F), charging is intelligently controlled by the MC75 and the charging accessory in order to ensure safe operation and optimize long-term battery life.

To accomplish this, for small periods of time, the MC75 or accessory alternately enables and disables battery charging to keep the battery at acceptable temperatures. The MC75 or accessory indicates when charging is disabled due to abnormal temperatures via its LED. See [Table 1-2](#).

Powering On the MC75

Press the **Power** button to turn on the MC75. If the MC75 does not power on, perform a warm boot. See [Resetting the MC75 on page 1-8](#).

When turning the MC75 on for the first time, the splash screen displays for about a minute as the MC75 initializes its flash file system, then the calibration window appears. Note that these windows also appear upon cold boot.



NOTE When the MC75 powers up after inserting a battery for the first time, the device boots and powers on automatically.

Calibrating the Screen

To calibrate the screen so the cursor on the touch screen aligns with the tip of the stylus:

1. Remove the stylus from its holder on the back of the MC75.
2. Carefully press and briefly hold the tip of stylus on the center of each target that appears on the screen.
3. Repeat as the target moves around the screen, then tap the screen to continue.

Checking Battery Status

To check the charge status of the main battery or backup battery in the MC75, tap **Start > Settings > System tab > Power** icon to display the **Power** window.

To save battery power, tap the **Advanced** tab and set the MC75 to turn off after a specified number of minutes.

Resetting the MC75

There are three reset functions, warm boot, cold boot and clean boot. A warm boot restarts the MC75 by closing all running programs. A cold boot also restarts the MC75, and also initializes some drivers. Data saved in flash memory or a memory card is not lost. A clean boot resets the MC75 to factory defaults.

Perform a warm boot first. If the MC75 still does not respond, perform a cold boot.

Performing a Warm Boot

Hold down the **Power** button for approximately five seconds. As soon as the MC75 starts to perform a warm boot release the **Power** button.

Performing a Cold Boot

To perform a cold boot:

1. Simultaneously press the **Power** button and the 1 and 9 keys.
2. The MC75 initializes.

Performing a Clean Boot



CAUTION A clean boot should only be performed by an authorized system administrator. You must connect the MC75 to AC power during a clean boot.

Removing AC power from the MC75 during a clean boot may render the MC75 inoperable.

A clean boot resets the MC75 to the factory default settings. All data in the **Application** folder is retained. You must download the Clean Boot Package file from the Support Central web site (<http://www.motorola.com/enterprisemobility/support>) and install on the MC75.

To perform a clean boot:

1. Download the Clean Boot Package from the Support Central web site (<http://www.motorola.com/enterprisemobility/support>). Follow the instructions included in the package for installing the package onto the MC75.
2. Simultaneously press the **Power** button and the **1** and **9** keys.
3. Immediately, as soon as the device starts to boot and before the splash screen is visible, press and hold the right scan button.
4. Insert the MC75 into a powered cradle.
5. The MC75 updates and then re-boots.
6. Calibrate the screen.

Waking the MC75

The wake-up conditions define what actions wake up the mobile computer after it has gone into suspend mode. The mobile computer can go into suspend mode by either pressing the Power button or automatically by Control Panel time-out settings. These settings are configurable and the factory default settings are shown in [Table 1-3](#) are subject to change/update.

Table 1-3 Wake-up Default Settings

Condition for Wake-up	Power Button	Automatic Time-out
AC power is applied.	No	Yes
Mobile computer is inserted into a cradle.	No	Yes
Mobile computer is removed from a cradle.	No	Yes
Mobile computer is connected to a USB device.	No	Yes
Mobile computer is disconnected from a USB device.	No	Yes
A key is pressed.	No	Yes
The scan triggered is pressed.	No	Yes
The screen is touched.	No	No
Audio Jack	No	No

Table 1-3 Wake-up Default Settings

Condition for Wake-up	Power Button	Automatic Time-out
Audio Btn	No	No
Bluetooth communication	Yes	Yes
Incoming phone call	Yes	Yes

Locking the MC75

Use the Device Lock feature to prevent use of the device. Note that when locked, the MC75 does not respond to screen or keypad input.

To lock the device, tap the **Device unlocked** icon on the **Today** screen. The icon changes to locked.

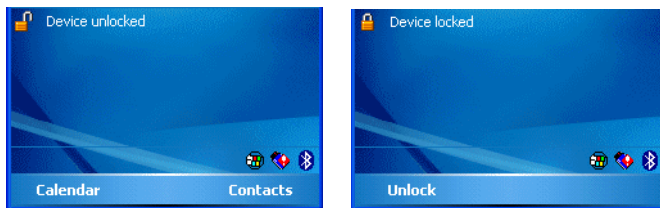
**Figure 1-6** Device Locked/Unlocked Icons

To unlock the device and free it for use, tap **Unlock**.

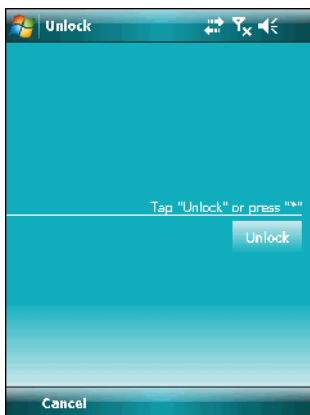
**Figure 1-7** Unlock Window

Tap **Unlock** on the *Unlock* window or press the * key.

Micro Secure Digital (microSD) Card

The microSD card slot provides secondary non-volatile storage. The slot is located on the side of the MC75 (see [Figure 1-8](#)). Refer to the documentation provided with the card for more information, and follow the manufacturer's recommendations for use.



CAUTION Follow proper ESD precautions to avoid damaging the SD card. Proper ESD precautions include, but are not limited to, working on an ESD mat and ensuring that the operator is properly grounded.

To install the microSD card:

1. Power off the MC75.
2. Remove the memory card cover on the side of the MC75 by loosening the two captive screws.

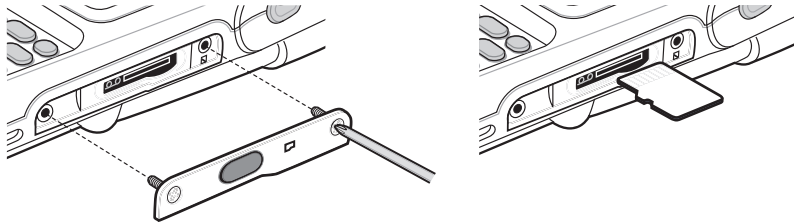

Figure 1-8 Card Installation

3. Insert the card with the card contacts facing up and the cut corner on the left, until you feel a click.
4. Replace the memory card cover and tighten the screws.

To remove an microSD card:

1. Power off the MC75.
2. Remove the memory card cover by loosening the screws.

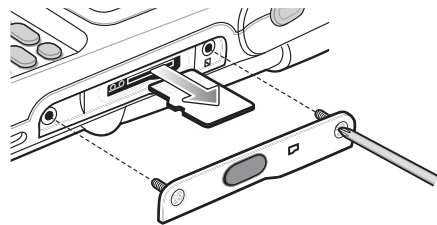

Figure 1-9 Card Removal

3. Carefully press and release the card to eject it.
4. Remove the card from the card slot.
5. Replace the memory card cover and tighten the screws.

Removing the Screen Protector

A screen protector is applied to the MC75. Motorola recommends using this to minimize wear and tear. Screen protectors enhance the usability and durability of touch screen displays.

To remove the screen protector, lift the corner using a thin plastic card, such as a credit card, then carefully lift it off the display.

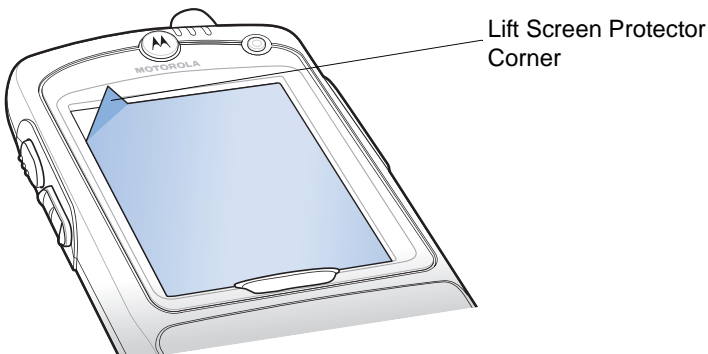

Figure 1-10 Removing the Screen Protector



CAUTION Do not use a sharp object to remove the protector. Doing so can damage the display.



NOTE Not using a screen protector can affect warranty coverage. To purchase replacement protectors, contact your local account manager or Motorola, Inc. These include screen protector installation instructions. Part number: KT-67525-01R Screen Protector 3/pk.

Replacing the Main Battery

1. Press the red **Power** button to suspend the MC75.
2. Loosen the handstrap.
3. Open the battery cover latches on either side of the battery cover.

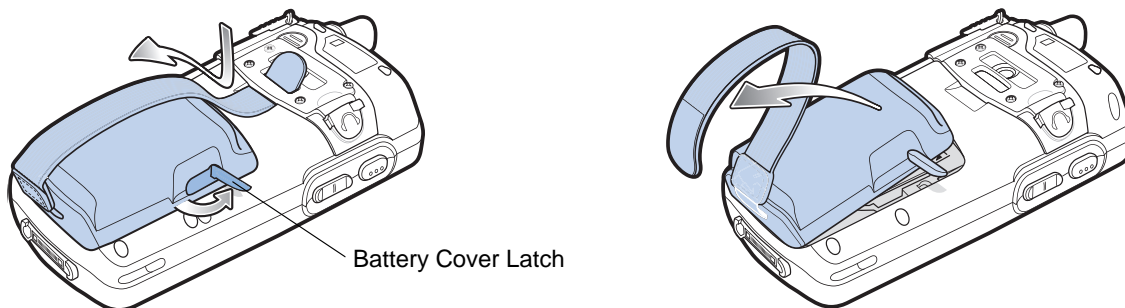

Figure 1-11 Removing the Battery Cover

4. Lift the top of the battery cover and remove.
5. Press the battery release latch on the bottom of the battery to unlock, and lift the battery out of the well.
6. Insert the replacement battery, top first, into the battery compartment in the back of the MC75.
7. Press the battery down into the battery compartment until the battery release latch snaps into place.



NOTE Position the battery correctly, with the battery charging contacts on top of the charging contacts in the battery compartment.

8. With the battery cover latches open, insert the cover, bottom first, then press down on the top of the cover.
9. Close the battery cover latches on either side of the battery cover.
10. Insert the handstrap through the handstrap slot, then tighten and press down to secure.

The MC75 powers up after inserting the battery and replacing the battery cover.

Chapter 2 Accessories

Introduction

MC75 accessories, listed below, provide a variety of product support capabilities.

- Four Slot Ethernet Cradle - Charges the MC75 main battery and connects the MC75 with an Ethernet network.
- Four Slot Charge Only Cradle - Charges up to four MC75 devices.
- Single Slot USB/Serial Cradle - Charges the MC75 main battery and a spare battery. Synchronizes the MC75 with a host computer through a USB or serial connection.
- Vehicle Cradle - Provides secure mounting of the MC75 in a vehicle. Charges the MC75 and a spare battery. Provides a serial port for data communication between an MC75 and an external device.
- Four Slot Battery Charger - Charges spare standard and high capacity batteries.
- Auto Charge Cable - Plugs into a vehicle cigarette lighter to charge the MC75 while on the road.
- Charge Only Cable - Provides power to the MC75.
- DEX Cable - Enables the transmission of data between the MC75 and a customer's inventory system at the time of delivery.
- Modem Inverter Cable - Connects the MC75 to the modem dongle.
- Modem Dongle - Provides modem connectivity.
- Printer Cables - Connects the MC75 to a printer.
- Serial Cable - Provides serial communication from cradle with a host computer.
- Serial Charging Cable - Provides power to the MC75 and serial communication with a host computer.
- USB Cable - Provides USB communication from cradle with a host computer.
- USB Charging Cable - Provides power to the MC75 and USB communication with a host computer.
- Belt Mounted Rigid Holster - Holds the MC75 when not in use.
- Belt Mounted Fabric Holster - Provides additional protection for the MC75.
- Headset - Used in noisy environments.

- Magnetic Stripe Reader - Snaps on to the MC75 and adds magstripe read capabilities.
- Debit Card Reader - Snaps onto the bottom of the MC75 to allow easy data capture with the swipe of a magnetic stripe card and personal identification number (PIN) entry using a numeric keypad.
- Snap-on Mobile Payment Module with Chip and PIN - snaps onto the bottom of the MC75 mobile computer to allow easy data capture with magnetic stripe cards, EMV compliant Chip and PIN cards and personal identification number (PIN) entry using a numeric keypad.

Single Slot USB/Serial Cradle

This section describes how to set up and use a Single Slot USB/Serial cradle with the MC75. For USB communication setup procedures see [Chapter 3, ActiveSync](#).

The Single Slot USB/Serial Cradle:

- Provides 5.4 VDC power for operating the MC75.
- Synchronizes information between the MC75 and a host computer. See [Chapter 3, ActiveSync](#) for information on setting up a partnership between the MC75 and a host computer.
- Charges the MC75's battery.
- Charges a spare battery.

Setup

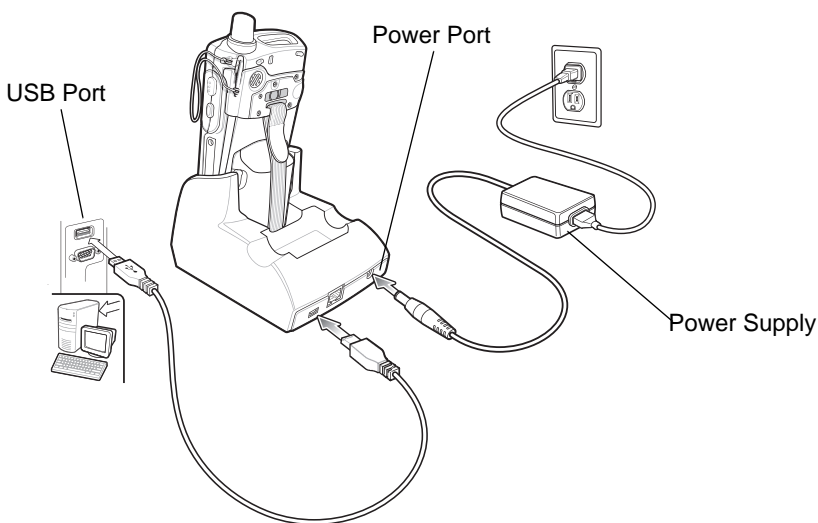

Figure 2-1 Single Slot USB/Serial Cradle Power and USB Connections

Charging the MC75 Battery

Connect the cradle to power. Insert the MC75 into the MC75 slot to begin charging.

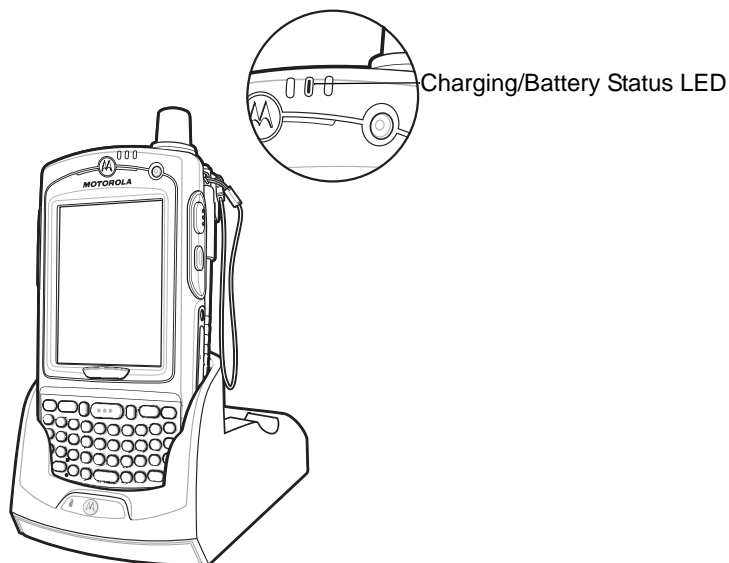

Figure 2-2 MC75 Battery Charging

Charging the Spare Battery

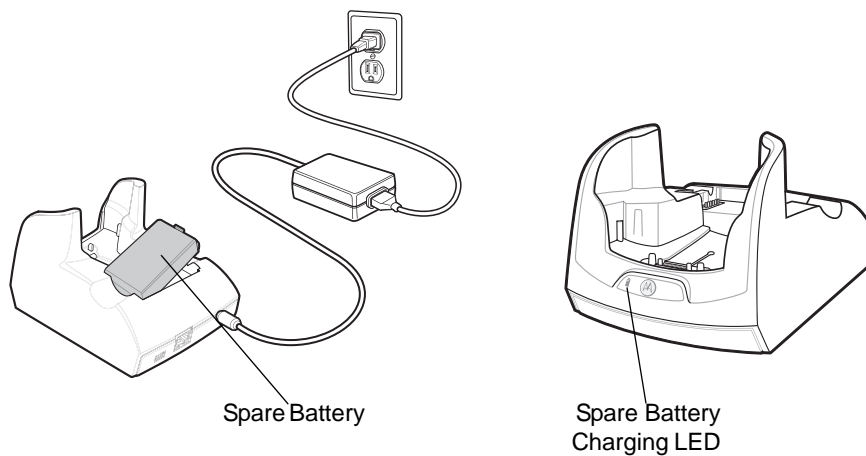

Figure 2-3 Spare Battery Charging

Battery Charging Indicators

The Single Slot USB/Serial Cradle charges the MC75's main battery and a spare battery simultaneously.

The MC75's Charge LED indicates the status of the battery charging in the MC75. See [Table 1-2 on page 1-7](#) for charging status indications.

The spare battery charging LED on the cradle indicates the status of the spare battery charging in the cradle. See [Table 2-1](#) for charging status indications.

The 3600 mAh battery fully charges in approximately five hours and the 4800 mAh battery fully charges in approximately seven hours.

Charging Temperature

Charge batteries in temperatures from 0°C to 40°C (32°F to 104°F). Charging is intelligently controlled by the MC75.

To accomplish this, for small periods of time, the MC75 or accessory alternately enables and disables battery charging to keep the battery at acceptable temperatures. The MC75 or accessory indicates when charging is disabled due to abnormal temperatures via its LED. See [Table 1-2 on page 1-7](#) and [Table 2-1](#).

Table 2-1 Spare Battery LED Charging Indicators

Spare Battery LED (on cradle)	Indication
Slow Blinking Amber	Spare battery is charging.
Solid Amber	Spare battery is fully charged.
Fast Blinking Amber	Charging error.
Off	Not charging.

Four Slot Ethernet Cradle

This section describes how to set up and use a Four Slot Ethernet cradle with the MC75.

The Four Slot Ethernet cradle:

- Provides 5.4 VDC power for operating the MC75.
- Connects the MC75 (up to four) to an Ethernet network.
- Simultaneously charges up to four MC75s.

You cannot ActiveSync using the Four Slot Ethernet cradle. To ActiveSync with a host computer, use the Single Slot USB/Serial cradle, USB Charging cable or Serial Charging cable.

Setup

Connect the Ethernet cradle to a power source and to an Ethernet switch, router, or hub, or a port on the host device.

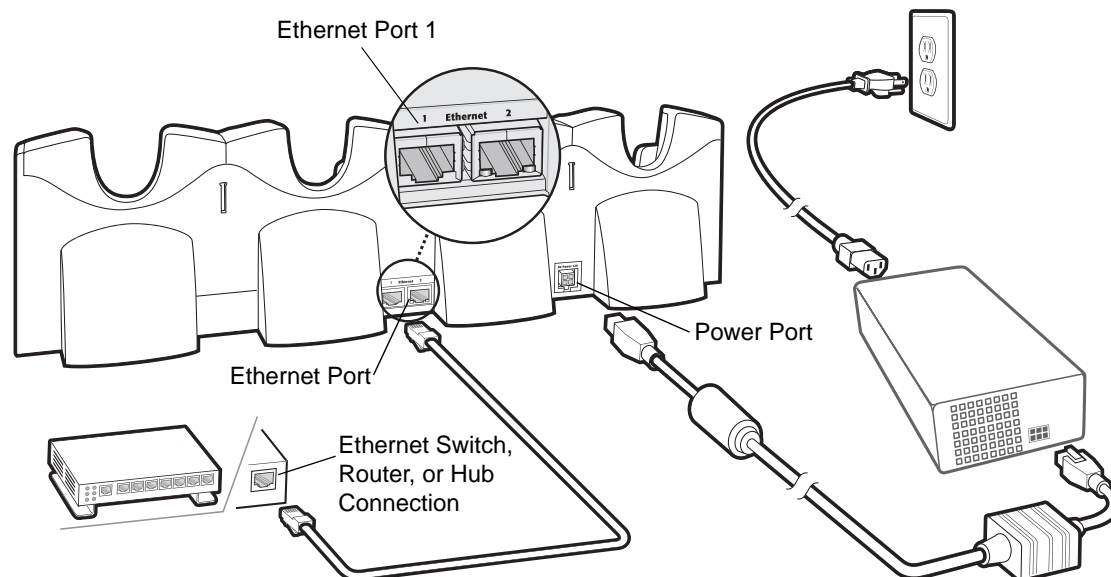

Figure 2-4 Four Slot Ethernet Cradle Connection

Daisy chaining Ethernet Cradles

Daisychain up to seven Ethernet cradles to connect several cradles to an Ethernet network. Use either a straight or crossover cable. Daisy chaining more than four Ethernet cradles can lead to reduction in bandwidth.

To daisychain more than one Ethernet cradle:

1. Connect power to each Ethernet cradle to daisychain.
2. Connect an Ethernet cable to Port 1 of the first cradle as shown in [Figure 2-4](#).
3. Connect a second Ethernet cable between Port 2 of the first cradle, and Port 1 of the second cradle.
4. Connect additional cradles as described in Step 3.

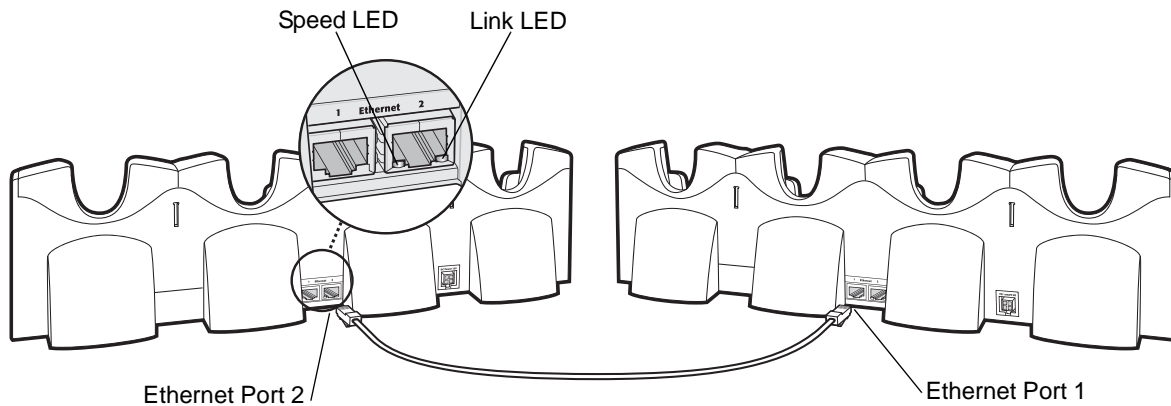

Figure 2-5 *Daisy chaining Four Slot Ethernet Cradles*

Bandwidth Considerations when Daisy chaining

Each cradle added to the daisy chain impacts the bandwidth provided to the inserted MC75s, particularly when the MC75s attempt to send and receive at data rates that exceed the bandwidth provided to the chain (typically 100 Mbps). If an MC75 in a daisy chained cradle does not use its bandwidth, that bandwidth is allocated to other inserted MC75s.

[Table 2-2](#) shows available bandwidth, based on 100 Mbps, for the maximum number of daisy chained cradles, with each attempting transmission at the maximum data rate.

Table 2-2 *Daisy chaining Bandwidth*

Daisy chained Cradles	Bandwidth Allocation For Each Ethernet Cradle (bits/sec)	Bandwidth Allocation For Each Mobile Computer (bits/sec)
Cradle 1	100,000,000	20,000,000
Cradle 2	20,000,000	4,000,000
Cradle 3	4,000,000	800,000
Cradle 4	800,000	160,000
Cradle 5	160,000	32,000
Cradle 6	32,000	6,400
Cradle 7	6,400	1,280

* The maximum bandwidth capacity for the mobile computer is 12,000,000 bits/sec.

** Depending on the application, allocated bandwidth may not be adequate.

Note: 100 Mbps is the theoretical maximum. This rate is never actually achieved in any Ethernet installation.

Ethernet Cradle Drivers

The MC75 includes Ethernet cradle drivers that initiate automatically when you place the MC75 in a properly connected Four Slot Ethernet cradle. After inserting the MC75, configure the Ethernet connection:

1. Tap **Start > Settings > Connections** tab > **WiFi** icon. The **Configure Network Adapters** window appears.

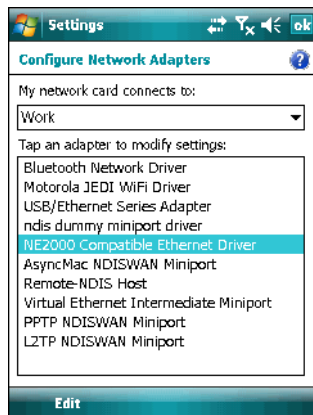

Figure 2-6 *Configure Network Adapters Window*

2. In the **My network card connects to:** drop-down list, select the appropriate connection.
3. In the **Tap an adapter to modify settings:** list, select **USB/Ethernet Series Adapter**.

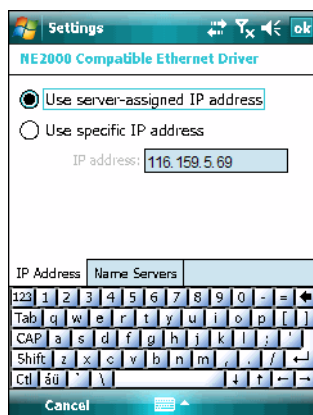

Figure 2-7 *IP Address Tab*

4. In the **IP address** window, select the appropriate radio button:
 - **Use server-assigned IP address**
or
 - **Use specific IP address.** Enter the IP address, Subnet mask, and Default gateway, as needed.
5. Tap the **Name Servers** tab.

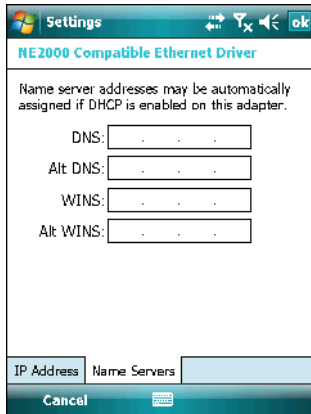

Figure 2-8 Name Servers Tab

6. Enter the appropriate DNS, Alt DNS, WINS, and Alt WINS server addresses.
7. Tap **ok**.

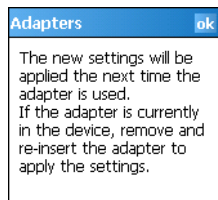

Figure 2-9 Adapters Dialog Box

8. Tap **ok** to confirm the setup.
9. Tap **ok** to exit.

Charging and Communication

Insert the MC75 into a slot to begin charging.

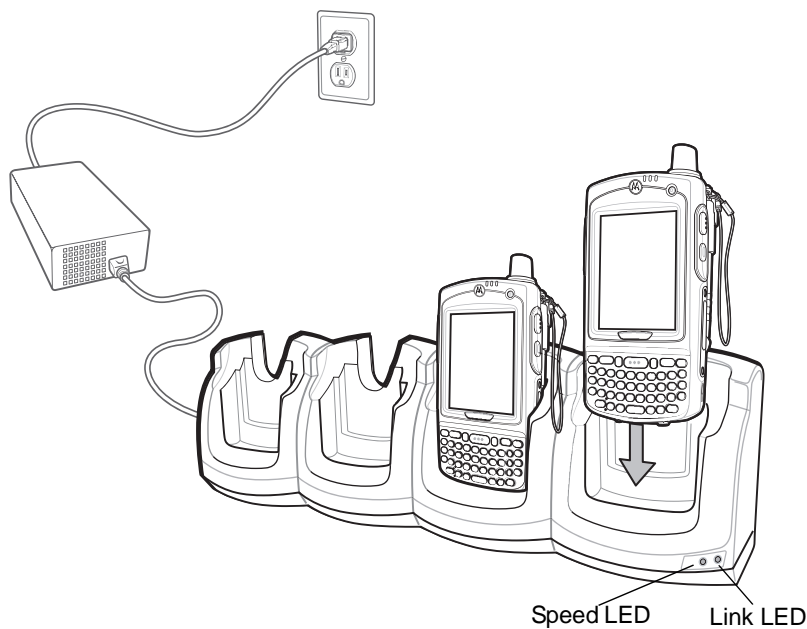

Figure 2-10 MC75 Battery Charging

LED Charging Indicators

Charge LED

The MC75's charge LED shows the status of the battery charging in the MC75. See [Table 1-2 on page 1-7](#) for charging status indications.

The 3600 mAh battery fully charges in approximately five hours and the 4800 mAh battery fully charges in approximately seven hours.

Speed LED

The cradle's green Speed LED lights to indicate that the transfer rate is 100 Mbps. When it is not lit it indicates that the transfer rate is 10Mbps.

Link LED

The cradle's yellow Link LED blinks to indicate activity, or stays lit to indicate that a link is established. When it is not lit it indicates there is no link.

Charging Temperature

Charge batteries in temperatures from 0°C to 40°C (32°F to 104°F). Charging is intelligently controlled by the MC75.

To accomplish this, for small periods of time, the MC75 or accessory alternately enables and disables battery charging to keep the battery at acceptable temperatures. The MC75 or accessory indicates when charging is disabled due to abnormal temperatures via its LED. See [Table 1-2 on page 1-7](#).

Four Slot Charge Only Cradle

This section describes how to set up and use a Four Slot Charge Only cradle with the MC75.

The Four Slot Charge only cradle:

- Provides 5.4 VDC power for operating the MC75.
- Simultaneously charges up to four MC75s.

You cannot ActiveSync using the Four Slot Charge Only cradle. To ActiveSync with a host computer, use the Single Slot USB/Serial cradle, USB Charging cable or Serial Charging cable.

Setup

Connect the Four Slot Charge Only cradle to a power source.

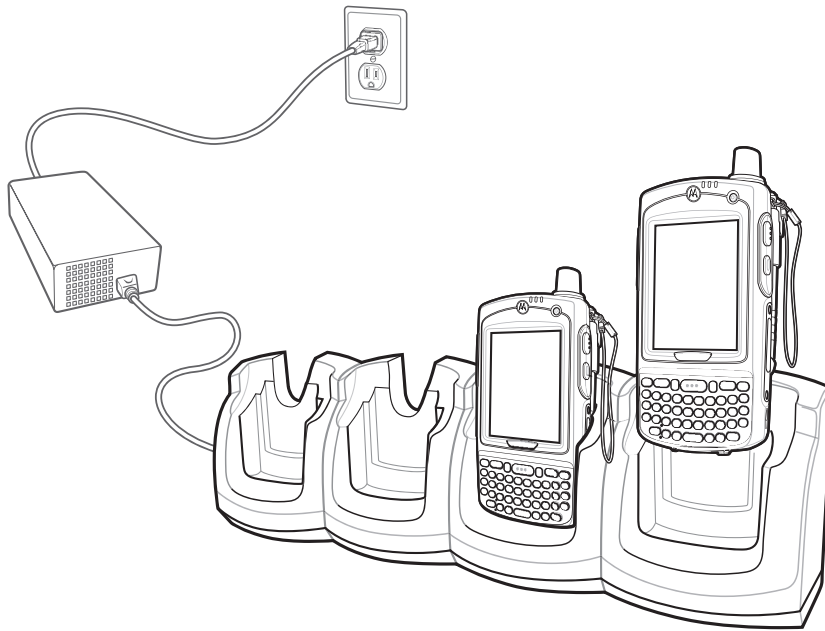

Figure 2-11 Four Slot Charge Only Cradle Connection

Charging Temperature

Charge batteries in temperatures from 0°C to 40°C (32°F to 104°F). Charging is intelligently controlled by the MC75.

To accomplish this, for small periods of time, the MC75 or accessory alternately enables and disables battery charging to keep the battery at acceptable temperatures. The MC75 or accessory indicates when charging is disabled due to abnormal temperatures via its LED. See [Table 1-2 on page 1-7](#).

Wall Mount Bracket

Use the optional Wall Mount Bracket to mount a four slot cradle to a wall. To attach the Wall Mount Bracket:

1. Use the Wall Mount Bracket as a template and mark the locations of the four mounting screws.

✓ **NOTE** Use fasteners appropriate for the type of wall and the Wall Mount Bracket mounting slots. The Wall Mount Bracket mounting slots are designed for a fastener with a #8 pan head.

2. Mount the fasteners to the wall. The screw heads should protrude about a half of an inch from the wall.
3. Slip the Wall Mount Bracket over the screw heads and slide the bracket down over the screw heads.
4. Tighten the screws to secure the bracket to the wall.

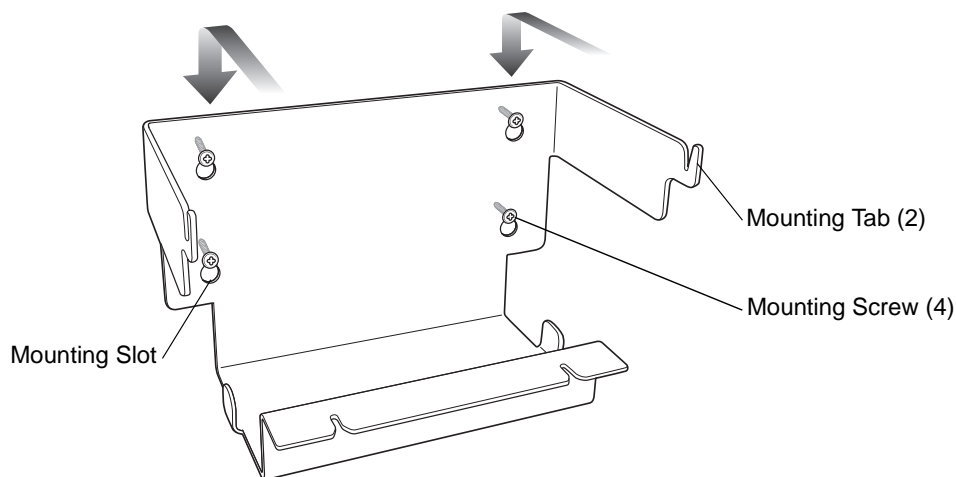

Figure 2-12 Wall Mount Bracket

To mount a four slot cradle:

1. Screw the supplied fasteners into the bottom of the four slot cradle. The screw heads should protrude about a quarter of an inch from the cradle.

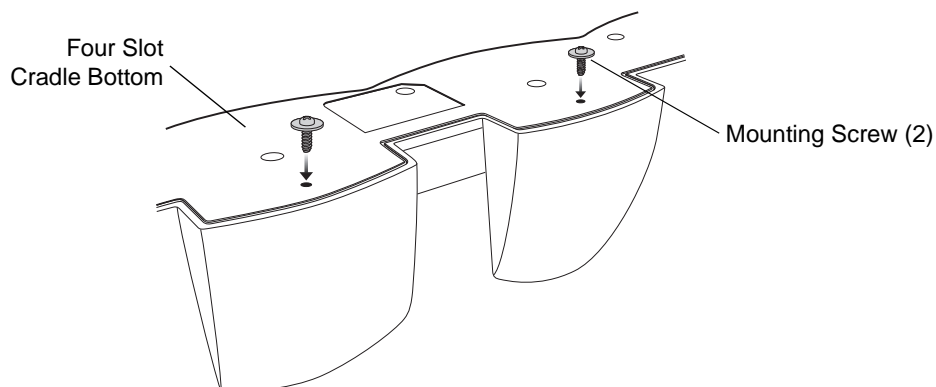

Figure 2-13 Cradle Mounting Screws

2. Align the Wall Mount Bracket mounting tabs with the mounting slots in the back of the four slot cradle. Slip the two mounting tabs into mounting slots.

3. Swing the four slot cradle down onto the mounting bracket and align the mounting screws so that they fit into the screw slots.

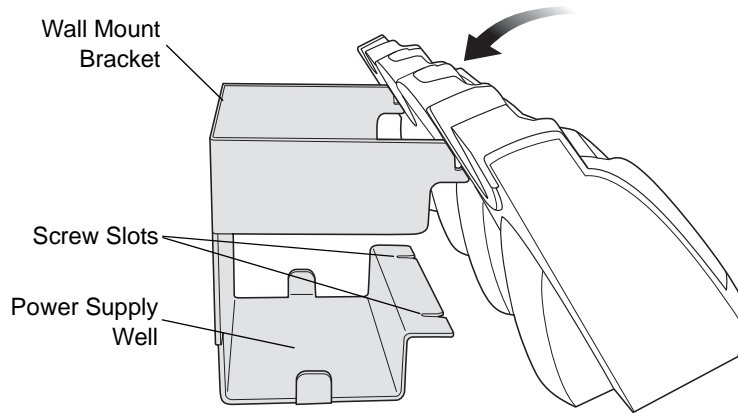

Figure 2-14 Wall Mount Bracket

4. Tighten the mounting screws to secure the four slot cradle to the bracket.

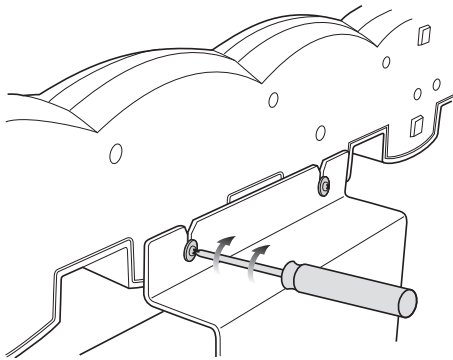

Figure 2-15 Mounting Screws

5. Connect power (see [Figure 2-4 on page 2-5](#)). The power supply should be located in the power supply well.

VCD7X00 Vehicle Cradle

This section describes how to set up and use a VCD7X00 vehicle cradle with the MC75.

Once installed in a vehicle, the cradle:

- holds the MC75 securely in place
- provides power for operating the MC75
- provides a serial port for data communication between an MC75 and an external device (e.g., a printer)
- re-charges the battery in the MC75
- re-charges a 3600 mAh or 4800 mAh battery.

Requirements

For mounting:

- four #8-32 self-locking nuts
- four #8 washers
- a drill with a #6 drill bit (.204").

For power connection:

- power input cable (included), p/n 25-61987-01R
- UL Listed in-line fuse rated 250V, 5A (included), must be used if not connecting to vehicle's fuse panel
- in-line fuse holder (included), must be used if not connecting to vehicle's fuse panel.

For serial connection:

- DB9 female serial cable (some devices may require null modem).

For communication:

- an MC75
- host computer setup and MC75 setup (as determined by the application you are using).

Connector Ports

There are two connection ports on the bottom of the vehicle cradle:

Table 2-3 *Vehicle Cradle Connection Ports*

Ports	Function
Serial	Standard RS 232 port used for direct connection to the serial device using a serial cable.
Power	Used for connecting to vehicle power using the power input cable.

Connector Pin-Outs

Table 2-4 Power Input Cable

Pin	Signal
1	Chassis ground (Black Wire)
2	Chassis ground (Bare Wire)
3	V+ (Red Wire)
4	V+ (Red Wire)

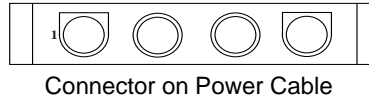
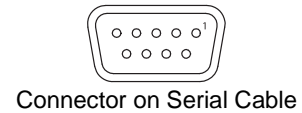

Table 2-5 Serial Cable

Pin	Signal	Pin	Signal
1	DCD	5	GND
2	RxD	6	DSR
3	TxD	7	RTS
4	DTR	8	CTS
5	GND	9	5V_OUT



CAUTION ROAD SAFETY - Do not use the MC75 while driving. Park the vehicle first. Always ensure the MC75 is fully inserted into the cradle. Do not place it on the seat or where it can break loose in a collision or sudden stop. Lack of proper insertion may result in property damage or personal injury. Motorola, Inc. is not responsible for any loss resulting from the use of the products while driving. Remember: Safety comes first.

Mounting the Cradle



CAUTION Only mount the Vehicle Cradle in a vertical position with the release level at the top or in a horizontal position with the MC75 display facing up. Never mount the vehicle cradle on the side or upside down or on a wall that can be subject to impact or collision of greater than 40Gs, in accordance with SAE J1455 Section 4.10.3.5

1. Select a mounting location for the cradle. It should be flat, and must provide adequate support for the cradle.
 - ✓ **NOTE** If using the GPS functionality of the MC75 mobile computer, ensure that the vehicle cradle is positioned so that the MC75 has a clear unobstructed view of the sky.
2. Prepare the mounting surface to accept four #8-32 studs, using the mounting template below. Drill four holes with a #6 drill bit.

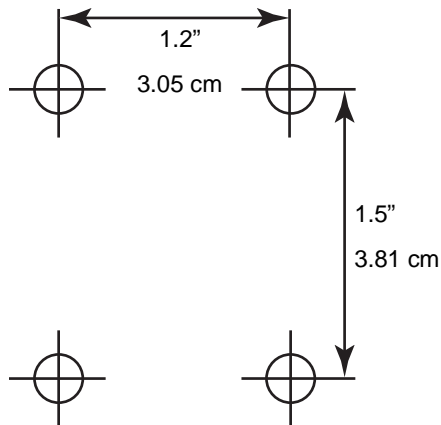

Figure 2-16 Vehicle Cradle Mounting Template

3. Position the cradle on the mounting surface.
4. Fasten it using four #8 washers and four #8-32 self-locking nuts.



CAUTION Do not install a VCD7000 Vehicle Cradle on or near an air bag cover plate or within an aerobic zone. Also, do not install it in a location that affects vehicle safety or driveability.

Power Connection

Please read all of the following instructions before beginning.



WARNING! A properly trained technician must perform the power connection. Improper connection can damage your vehicle, cradle or MC75. Refer to the vehicle's Owner's Manual for instructions for removing power.

To connect the cradle to power:



CAUTION When setting up connection for this cradle, only use the power input cable provided with this cradle.

1. Locate the vehicle power source.



NOTE The ideal location for connecting the vehicle cradle power input cable would be an accessory output in your vehicle's fuse panel. The vehicle cradle should be added to a circuit with a maximum load capacity for the cradle and the original circuit. Refer to the vehicle's *Owner's Manual* for identification of the circuit. If a fused output is not available, the vehicle cradle must be installed with the provided in-line fuse holder and UL Listed 5A fuse. The fuse protects the vehicle from an electrical short on the power line to the cradle. To use the cradle to charge the MC75 and spare battery when the vehicle's ignition is off, connect the cradle to unswitched power. This will affect the vehicle's battery charge.

2. Route the power input cable from the cradle's power port to the connection point for the vehicle's power source.



CAUTION The means of routing and securing the power input cable from the cradle through to the vehicle power source is extremely important. Hazards associated with improper wiring can be severe. To avoid unintentional contact between the wire and any sharp edges, provide the cable with proper bushings and clamping where it passes through openings. If the wire is subjected to sharp surfaces and excess engine vibration, the wiring harness insulation can wear away, causing a short between the bare wire and chassis. This can start a fire. To avoid any mishaps, all wiring should be routed away from moving parts, high temperature areas and any contaminants.

3. When using the supplied in-line fuse holder (which must be used if not connecting to vehicle's fuse panel):
 - a. Ensure the fuse holder contains a 5A UL Listed slow-blow fuse.
 - b. Splice the fuse holder to the end of the red V+ wire, as shown above. Make the distance from the fuse to the power connection point as short as possible.

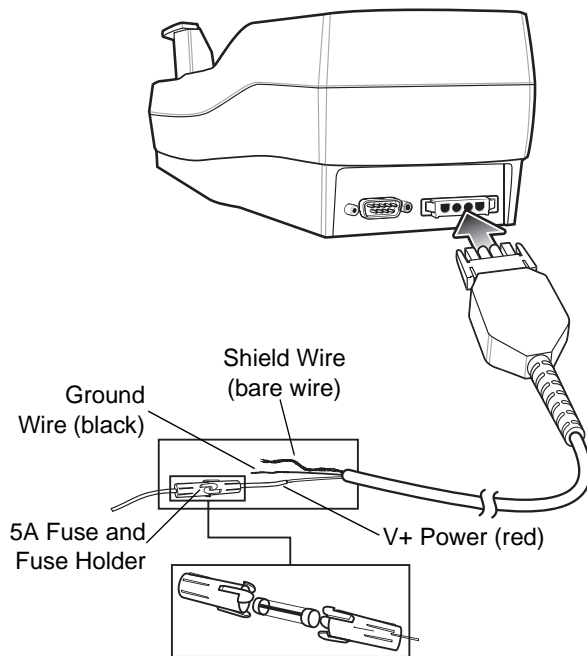

Figure 2-17 Vehicle Cradle Power Connection

4. Prepare the cable termination.
 - a. Red wire: connect to a +12/24 V vehicle power source.
 - b. Black wire and Shield wire: connect to vehicle ground wire or chassis ground.



NOTE How the cable terminates depends on the vehicle. If the vehicle has a power output connector, then you must attach a mating connector to the end of the power cable. You may be able to connect to a fuse panel with a simple blade terminal or commercially available connector. Consult the vehicle *Owner's Manual* for information on how to access the power supply in the vehicle.

5. Connect the power input cable into the power port on the cradle.

To see if the cradle has power, insert the MC75. The Charging LED on the MC75 blinks slowly to indicate charging and turns solid amber when the battery is completely charged. See [Table 1-2 on page 1-7](#) for other indications.

Serial Device Connection

The MC75 has a serial port on the bottom. When the MC75 is inserted into the cradle, it connects to the cradle's serial port. The MC75 can then use the cradle's serial port to communicate with an external device.

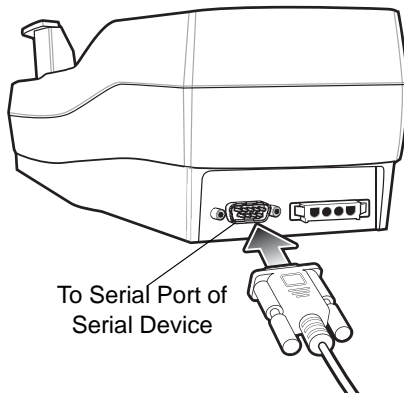

Figure 2-18 Vehicle Cradle Serial Connection

To provide serial communications between an MC75 and a serial device, connect one end of the 9-pin serial cable into the serial port on the cradle, and the other end into the serial port on the serial device.

✓ **NOTE** Some devices may require a null modem serial cable.

To begin communication:

1. Insert the MC75 into the cradle.
2. To initiate communication, make appropriate selections on the MC75, as determined by the application you are using.

⚠ **CAUTION** Removing the MC75 during data communication disrupts communication between the MC75 and the attached device.

Charging the MC75 Battery

Insert the MC75 into the vehicle cradle to begin charging. A click indicates that the MC75 button release locking mechanism is enabled and the MC75 is locked in place.

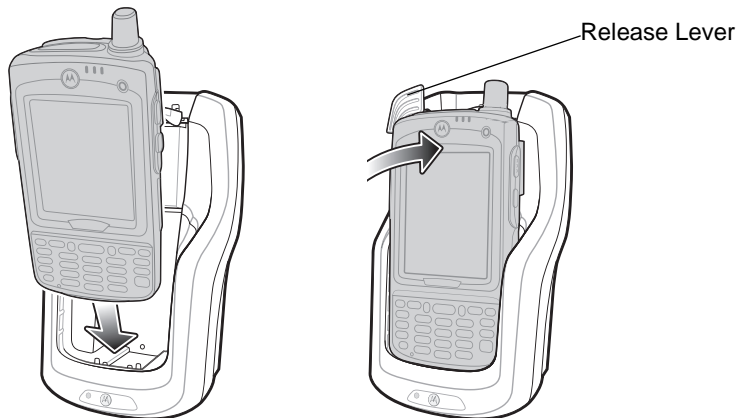

Figure 2-19 MC75 Battery Charging



CAUTION Ensure the MC75 is fully inserted in the cradle. Lack of proper insertion may result in property damage or personal injury. Motorola, Inc. is not responsible for any loss resulting from the use of the products while driving.

Removing the MC75

To remove the MC75, hold back the release lever on the cradle and pull the MC75 up and out of the cradle.

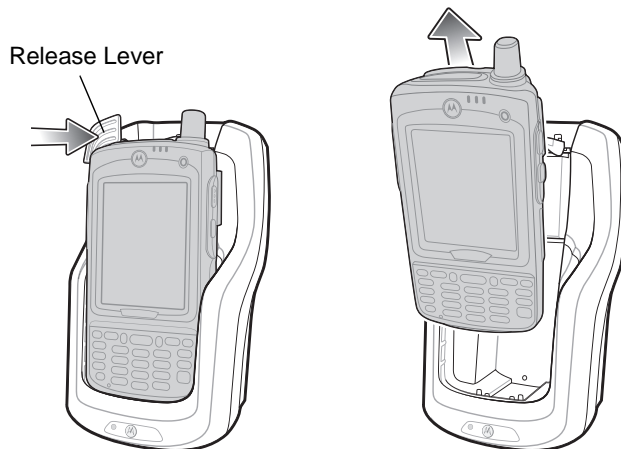

Figure 2-20 Removing the MC75

Charging the Spare Battery

Insert a spare battery to begin charging:

1. Lift the battery release lever.

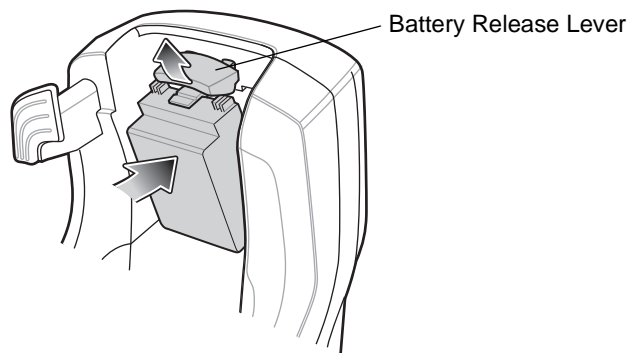

Figure 2-21 *Inserting the Spare Battery*

2. Insert the spare battery in the spare battery charging slot in the cradle with the charging contacts facing up and to the rear of the cradle.
3. Release the battery release lever. The battery release lever locks the spare battery into place.

To remove a spare battery, hold back the battery release lever and lift the battery from the spare battery slot.

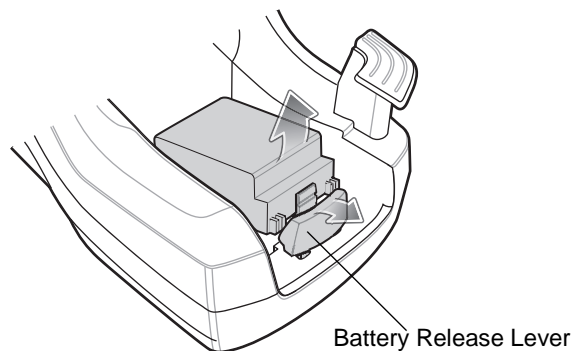

Figure 2-22 *Removing the Spare Battery*

Battery Charging Indicators

The Vehicle Cradle charges the MC75's main battery and a spare battery simultaneously.

The MC75's charge LED indicates the status of the battery charging in the MC75. See [Table 1-2 on page 1-7](#) for charging status indications.

The spare battery charging LED on the cradle indicates the status of the spare battery charging in the cradle. See [Table 2-6](#) for charging status indications.

The 3600 mAh battery fully charges in approximately five hours and the 4800 mAh battery fully charges in approximately seven hours.

Table 2-6 *Vehicle Cradle Spare Battery LED Charging Indicators*

Spare Battery LED (on cradle)	Indication
Slow Blinking Amber	Spare battery is charging.
Solid Amber	Spare battery is fully charged.
Fast Blinking Amber	Charging error.
Off	Not charging.

Charging Temperature

Charge batteries in temperatures from 0°C to 40°C (32°F to 104°F). Charging is intelligently controlled by the MC75.

To accomplish this, for small periods of time, the MC75 or accessory alternately enables and disables battery charging to keep the battery at acceptable temperatures. The MC75 or accessory indicates when charging is disabled due to abnormal temperatures via its LED. See [Table 1-2 on page 1-7](#) and [Table 2-6](#).

Four Slot Battery Charger

This section describes how to use the Four Slot Battery Charger to charge up to four MC75 spare batteries.

Battery Shim Installation

Before charging a spare battery, snap the MC75 shim into the battery slot as shown in [Figure 2-23](#).

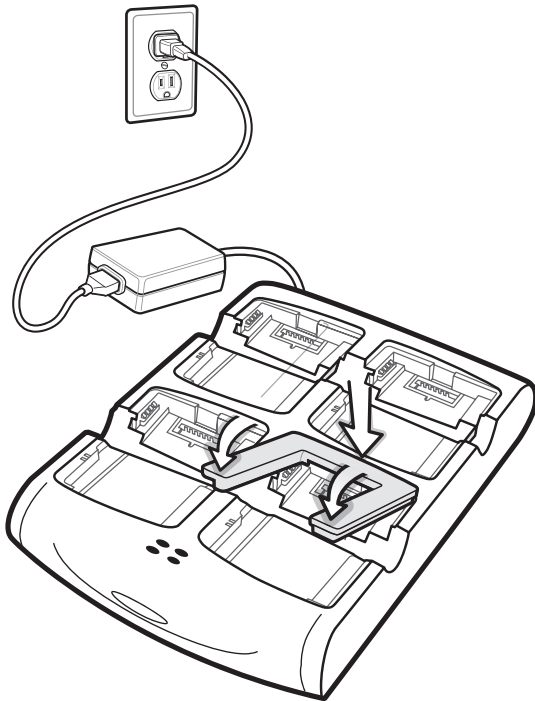

Figure 2-23 Spare Battery Shim Installation

✓ **NOTE** To purchase additional shims, contact your local account manager or Motorola, Inc. Part number: KT-76490-01R.

Spare Battery Charging

1. Connect the charger to a power source.
2. Insert the spare battery into a spare battery charging well and gently press down on the battery to ensure proper contact.

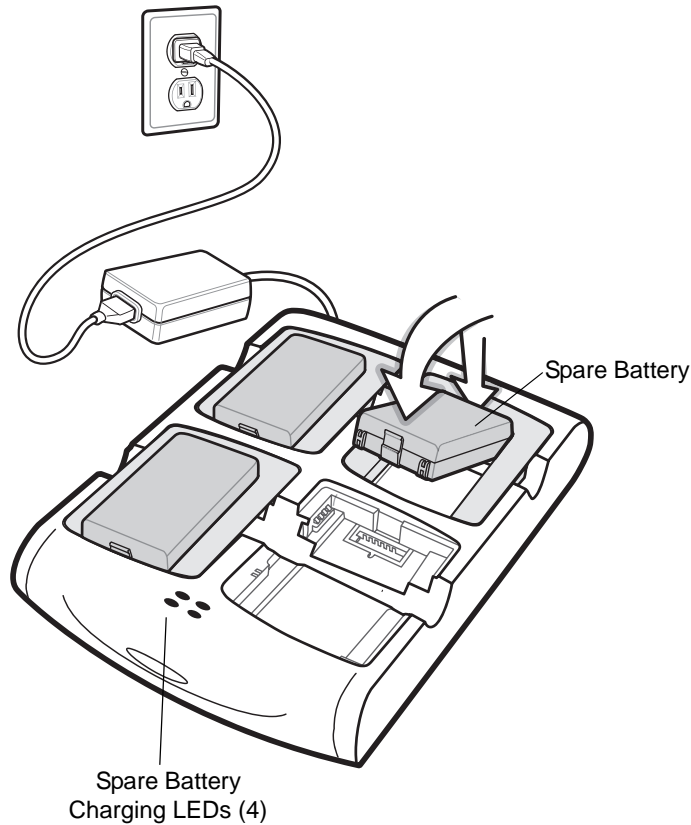

Figure 2-24 Four Slot Spare Battery Charger

Battery Charging Indicators

An amber LED is provided for each battery charging well. See [Table 2-7](#) for charging status indications. The 3600 mAh battery fully charges in approximately five hours and the 4800 mAh battery fully charges in approximately seven hours.

Charging Temperature

Charge batteries in temperatures from 0°C to 40°C (32°F to 104°F). Charging is intelligently controlled by the charger in order to ensure safe operation and optimize long-term battery life.

To accomplish this, for small periods of time, the charger alternately enables and disables battery charging to keep the battery at acceptable temperatures. The charger indicates when charging is disabled due to abnormal temperatures via its LED. See [Table 2-7](#).

Table 2-7 Spare Battery LED Charging Indicators

LED	Indication
Off	No spare battery in slot; spare battery not placed correctly; cradle is not powered.
Fast Blinking Amber	Error in charging; check placement of spare battery.
Slow Blinking Amber	Spare battery is charging.
Solid Amber	Charging complete.

Magnetic Stripe Reader (MSR)

This section describes how to set up and use the snap-on MSR with the MC75. The MSR snaps on to the bottom of the MC75 and removes easily when not in use.

When attached to the MC75, the MSR allows the MC75 to capture data from magnetic stripe cards. To download sample MSR data capture software, visit <http://www.motorola.com/enterprisemobility/support>.

Attaching and Removing the MSR

To attach, slide the MSR onto the bottom of the MC75 and snap it in place.

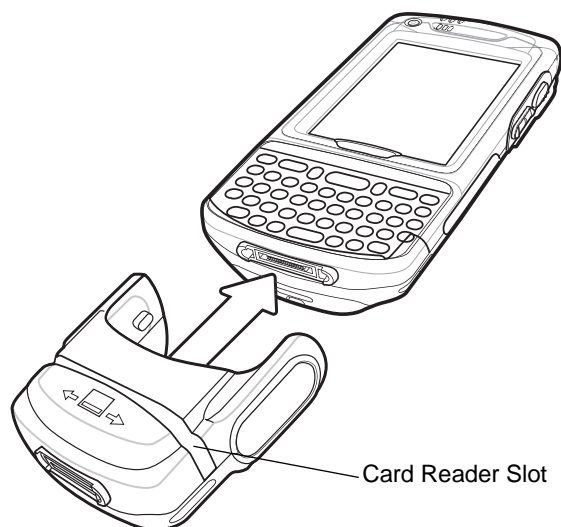

Figure 2-25 MSR Installation

To remove the MSR open the arms and pull the MSR from the MC75.

Using the MSR

The *MSR3000* sample application illustrates how an application handles MSR inputs (refer to *Motorola Enterprise Mobility Applications User's Guide*).

To use the MSR:

1. Attach the MSR to the MC75.
2. Power on the MC75.
3. Tap **Start > MC75 Demo > Test Apps > MSR MC75** or **MSR Cameo** to start the sample application.
4. Swipe the magnetic stripe card through the MSR, with the magnetic stripe on the card facing down. Swipe the card in either direction, from left to right or from right to left. For best results, gently press down on the card while swiping to ensure contact with the bottom of the reader.

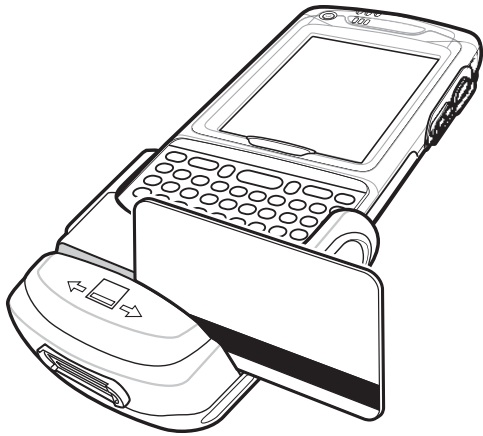

Figure 2-26 *Magnetic Stripe Card Swiping*

Debit Card Reader

The DCR7X00-100R Debit Card Reader (DCR) snaps onto the bottom of the MC75 mobile computer to allow easy data capture with the swipe of a magnetic stripe card and personal identification number (PIN) entry using a numeric keypad.

Getting Started

When using the DCR for the first time, charge the DCR in a cradle for a minimum of three hours.

Installation

1. Align the DCR with the bottom of the MC75 and push up until the locking tabs snap into place.

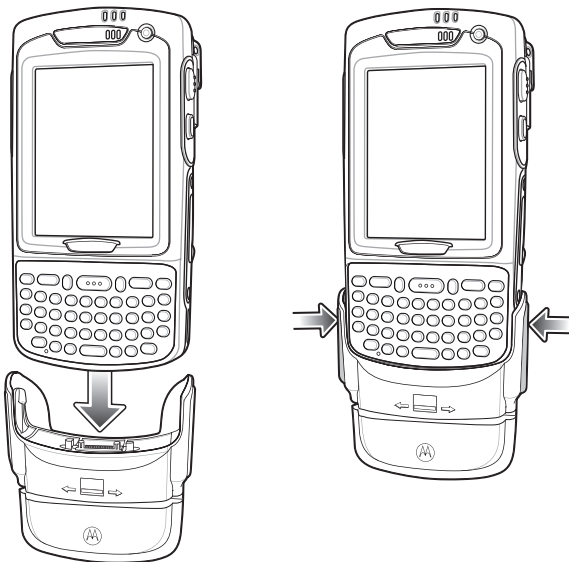

Figure 2-27 *Installation*

2. Pull on the DCR to ensure it is securely connected to the MC75.

Removal

To remove the DCR from the MC75, push in the bottom of the two locking tabs and pull the DCR from the MC75.

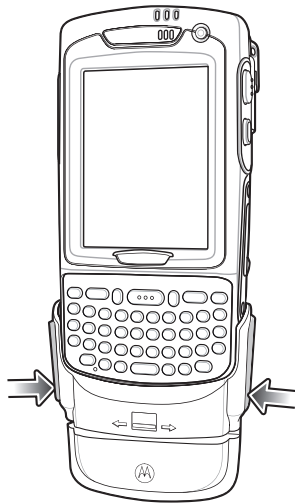

Figure 2-28 Removal

Credit Card Transactions

Launch a transaction application on the MC75. In the application, select Credit Card transaction.

Swipe the credit card through the magnetic stripe reader (MSR) slot, orienting the magnetic stripe as shown. Data encoded on the credit card is captured and, depending on the application, may display in an application data field.

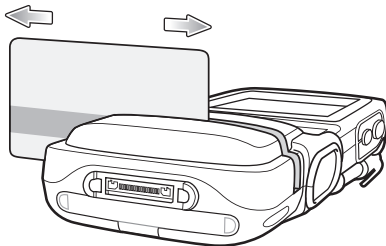

Figure 2-29 Swipe Card



NOTE Swipe the card in either direction, from left to right, or right to left. For best results, gently press down on the card while swiping to ensure contact with the bottom of the slot.

Debit Card Transactions

Launch a transaction application on the MC75. In the application, select Debit Card transaction.

Swipe the debit card through the MSR slot, orienting the magnetic stripe as shown. Data encoded on the debit card is captured and, depending on the application, may display in an application data field.

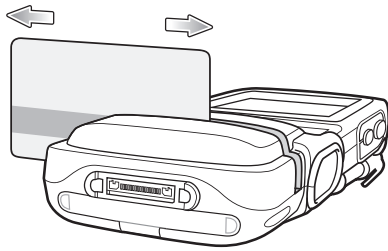

Figure 2-30 *Swipe Card*

- ✓ **NOTE** Swipe the card in either direction, from left to right, or right to left. For best results, gently press down on the card while swiping to ensure contact with the bottom of the slot.

Turn the MC75 over and present the DCR keypad to the customer. The customer enters their PIN following the instructions on the DCR display.



Figure 2-31 *Enter PIN on DCR*





Keypad

The back of the DCR contains a display and a numeric keypad for entering data.



Figure 2-32 *DCR Keypad*

Table 2-8 Keypad Key Descriptions

Key	Description
Numeric 	Used to enter PIN.
Cancel 	Cancels the current transaction.
Clear 	Clears the entered data.
Enter 	Submits the entered data.

Display Messages

The follow messages may appear on the DCR display:

ENTER PIN - A PIN is required to complete the transaction.

PIN ERR - The entered PIN is not between 4 and 12 characters.

CANCELED - The transaction was cancelled by the user.

COMPLETE - The transaction was completed.

KEYCLEAR - The DCR was tampered with or the battery completely discharged. The DCR must have the key re-injected. See your system administrator.

BATT OK - Battery is significantly charged.

BATT LOW - Battery charge is low. Re-charge as soon as possible.

STAND BY - DCR is performing a firmware check. This occurs if it has been powered off for more than 24 hours.

Check the DCR Battery Level

When the DCR is not used for extended periods of time or in storage it must be charged periodically to maintain the battery charge. Motorola recommends charging the DCR once every three months.

If the DCR battery fully discharges the debit function will be inoperable but the MSR will still function for credit card transactions. Return the DCR for service.

✓ **NOTE** While the DCR is being used in normal operation (application is accessing the DCR port), the DCR charges from the MC75.

To check the battery level:

1. Remove the DCR from the MC75.
2. Press and hold the 5 key until the battery status displays on the DCR display.
 - **BATT OK** - Battery is significantly charged

- **BATT LOW** - Battery charge is low.

If **BATT LOW** displays, charge the DCR for approximately three hours.

To charge the DCR, place it in a cradle or connect it to a charging cable. The DCR also charges when connected to the MC75 and the transaction application is running.

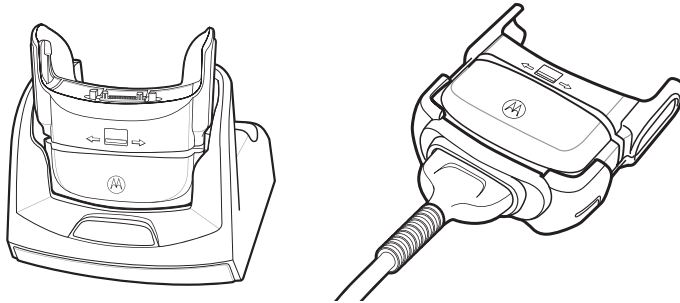

Figure 2-33 Charging the DCR

Charging the MC75

You can charge the MC75 while the DCR is attached. Place the MC75 with the DCR into a cradle to charge the MC75.

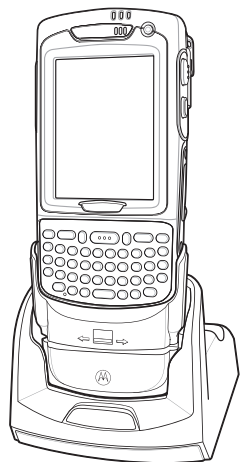

Figure 2-34 Charging the MC75 with the DCR Attached



NOTE If you are going to replace the MC75 battery, remove the DCR from the MC75 before replacing the battery.

Key Injection

If the DCR was tampered with or the battery has completely discharged, “**KEYCLEAR**” displays on the DCR display. The key must be re-injected into the DCR. For key loading instructions see your system administrator or contact customer service.

Maintenance

There are no serviceable part in the DCR. Do not tamper with the device. If the DCR is opened the key will be cleared.

Snap-on Mobile Payment Module with Chip and PIN

The DCR7X00-200R Snap-on Mobile Payment Module with Chip and PIN smart card reader snaps onto the bottom of the MC75 mobile computer to allow easy data capture with magnetic stripe cards, EMV compliant Chip and PIN cards and personal identification number (PIN) entry using a numeric keypad. This guide describes how to install and use the module.

Installation

✓ **NOTE** The module only functions when attached to the MC70/MC75.

1. Align the module with the bottom of the MC75 and push up until the locking tabs snap into place.

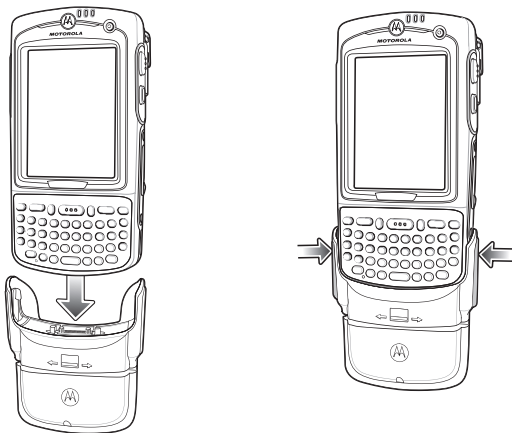

Figure 2-35 Attach Module to MC75

2. Pull on the module to ensure it is securely connected to the MC75.

Removal

To remove the module from the MC75, push in the bottom of the two locking tabs and pull the module from the MC75.

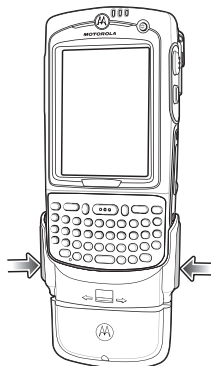

Figure 2-36 Press Latches In to Lock

Credit Card Transactions

- ✓ **NOTE** Credit Card transactions will function without an encryption key injected but will not function if a tamper event occurs.

Launch a transaction application on the MC75. In the application, select Credit Card transaction.

Swipe the credit card through the magnetic stripe reader (MSR) slot, orienting the magnetic stripe as shown. Data encoded on the credit card is captured and, depending on the application, may display in an application data field.

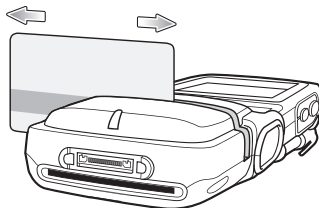

Figure 2-37 *Swipe Card*

- ✓ **NOTE** Swipe the card in either direction, from left to right, or right to left. For best results, gently press down on the card while swiping to ensure contact with the bottom of the slot.

Debit Card Transactions

- ✓ **NOTE** Debit Card transactions will only function with an encryption key injected. It will not function if a tamper event occurs.

Launch a transaction application on the MC75. In the application, select Debit Card transaction.

Swipe the debit card through the MSR slot, orienting the magnetic stripe as shown. Data encoded on the debit card is captured and, depending on the application, may display in an application data field.

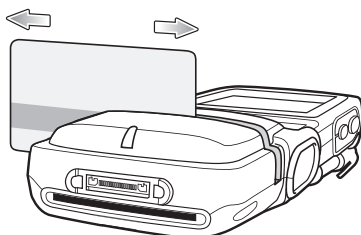

Figure 2-38 *Swipe Card*

- ✓ **NOTE** Swipe the card in either direction, from left to right, or right to left. For best results, gently press down on the card while swiping to ensure contact with the bottom of the slot.

Turn the MC75 over and present the keypad to the customer. The customer enters their PIN following the instructions on the display.



Figure 2-39 Enter PIN

Chip and PIN Transactions

- ✓ **NOTE** Chip and PIN transactions will function without an encryption key injected but will not function if a tamper event occurs.

Launch a transaction application on the MC75. In the application, select Chip and PIN transaction.

Customer inserts the Chip and Pin card into the slot, orienting the card with the contacts facing down and toward the DCR keypad.

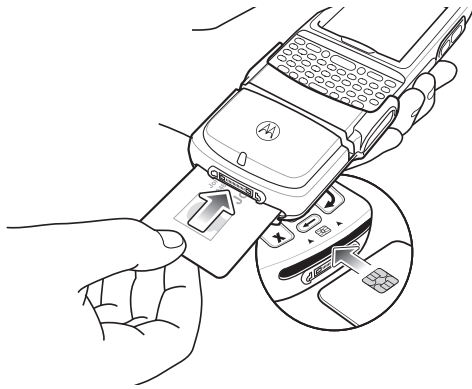

Figure 2-40 Insert Card

Customer turns the MC75 over, and enters their PIN following the instructions on the display.

Customer removes the card when transaction is complete.





Keypad

The back of the module contains a display and a numeric keypad for entering data.



Figure 2-41 Keypad

Table 2-9 Keypad Button Descriptions

Key	Description
Numeric 	Used to enter PIN.
Cancel (Red) 	Cancels the current transaction.
Clear (Yellow) 	Clears the entered data.
Enter (Green) 	Submits the entered data.

Display Messages

After connecting the module to the MC70/MC75 and an application opens the COM port, the following displays:



Figure 2-42 Display

Line 1 indicates the model number and the firmware version. The firmware version displays after the model number. In this example the firmware version is 0.09.

Line 2 indicates the keyload code. Each characters of the keyload code represents a different key type.

Table 2-10 *Keyload Codes*

Display	Operating Status
D - - - - D M M - - D - - M M - M M - - - - - M M - - - - -	Normal
d - - - - d m m - - d - - m m - m m - - - - - m m	Return to key injection facility.
* * * * * Blank display	Return to Motorola for service.

The follow messages may appear on the display:

Table 2-11 *Display Messages*

Message	Description
Line 1: Line 2: Enter PIN	Instructs the user to enter their PIN.
Line 1: PIN Line 2: ENT to Accept	Displays "*" as PIN is entered and instructs the user to press enter key when done.

Headset

Use the headset to communicate via Voice-over-IP (VoIP) or for audio playback. To connect the headset, remove the plug from the headset jack at the top of the MC75 and insert the headset connector. Contact a Motorola representative for compatible headsets.

For best performance, Motorola recommends a 2.5 mm jack headset, p/n 50-11300-050R.

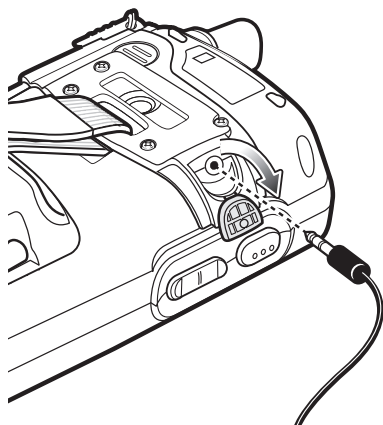

Figure 2-43 *Headset Connection*

Cables

This section describes how to set up and use the cables. The cables are available with a variety of connection capabilities.

The following MC75 communication/charge cables are available:

- Serial (RS232) Charge cable (9-pin D female with power input receptacle)
- USB Client Charge cable (standard-A connector and a barrel receptacle for power)
- Auto charge cable
- DEX cable
- Modem inverter cable
- Charge only cable.

The following printer cables are available directly from Motorola.

- O'Neil Printer cable
- Zebra Printer cable.

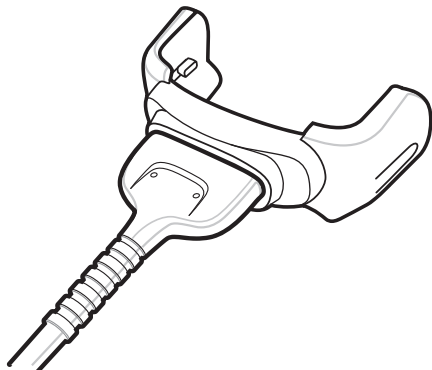

Figure 2-44 Cables (MC75 Connector)

The communication/charge cables:

- Provide the MC75 with operating and charging power.
- Synchronize information between the MC75 and a host computer. With customized or third party software, it can also synchronize the MC75 with corporate databases.
- Provide serial connection through the serial pass-through port for communication with a serial device, such as a host computer. For communication setup procedures, see [Communication Setup on page 2-37](#).
- Provide USB connection through the USB pass-through port for communication with a USB device, such as a host computer. For communication setup procedures, see [Communication Setup on page 2-37](#).

Dedicated printer cables provide communication with a printer.

Setup

The MC75 communication/charge cables can connect with a serial/USB device, such as a printer or host computer, through its serial or USB port.

Battery Charging

The communication/charge cables can charge the MC75 battery and supply operating power.

To charge the MC75 battery:

1. Connect the communication/charge cable power input connector to the Symbol approved power source.
2. Slide the bottom of the MC75 into the connector end of the communication/charge cable and gently press in until it latches into the MC75. The MC75 amber Charge LED indicates the MC75 battery charging status. The 3600 mAh battery fully charges in approximately five hours and the 4800 mAh battery fully charges in approximately seven hours. See [Table 1-2 on page 1-7](#) for charging status indications.
3. When charging completes, remove the cable by gently pulling the MC75 and the cable apart.

LED Charge Indications

The amber Charge LED on the MC75 indicates battery charging status. See [Table 1-2 on page 1-7](#) for charging status indications.

Charging Temperature

Charge batteries in temperatures from 0°C to 40°C (32°F to 104°F). Charging is intelligently controlled by the MC75.

To accomplish this, for small periods of time, the MC75 alternately enables and disables battery charging to keep the battery at acceptable temperatures. The MC75 indicates when charging is disabled due to abnormal temperatures via its LED. See [Table 1-2 on page 1-7](#).

Communication Setup

To connect an MC75 communication/charge cable to a serial or USB device:

1. Connect the serial/USB end of the MC75 communication/charge cable to the communication port of the device.
2. Connect the MC75 connector end of the cable to the MC75. For more information on communication setup procedures, see [Chapter 3, ActiveSync](#).

Chapter 3 ActiveSync

Introduction

To communicate with various host devices, install Microsoft ActiveSync (version 4.5 or higher) on the host computer. Use ActiveSync to synchronize information on the mobile computer with information on the host computer. Changes made on the mobile computer or host computer appear in both places after synchronization.

- ✓ **NOTE** When a mobile computer with Windows Mobile 6 is connected to a host computer and an ActiveSync connection is made, the WLAN radio (if applicable) is disabled. This is a Microsoft security feature to prevent connection to two networks at the same time.

ActiveSync software:

- Allows working with mobile computer-compatible host applications on the host computer. ActiveSync replicates data from the mobile computer so the host application can view, enter, and modify data on the mobile computer.
- Synchronizes files between the mobile computer and host computer, converting the files to the correct format.
- Backs up the data stored on the mobile computer. Synchronization is a one-step procedure that ensures the data is always safe and up-to-date.
- Copies (rather than synchronizes) files between the mobile computer and host computer.
- Controls when synchronization occurs by selecting a synchronization mode, e.g., set to synchronize continually while the mobile computer is connected to the host computer, or set to only synchronize on command.
- Selects the types of information to synchronize and control how much data is synchronized.

Installing ActiveSync

To install ActiveSync on the host computer, download version 4.5 or higher from the Microsoft web site at <http://www.microsoft.com>. Refer to the installation included with the ActiveSync software.

Mobile Computer Setup

- ✓ **NOTE** Microsoft recommends installing ActiveSync on the host computer before connecting the mobile computer.

The mobile computer can be set up to communicate either with a USB connection. [Chapter 2, Accessories](#) provides the accessory setup and cable connection information for use with the mobile computer. The mobile computer communication settings must be set to match the communication settings used with ActiveSync.

1. On the mobile computer tap **Start > Programs > ActiveSync** icon. The **ActiveSync** window appears.

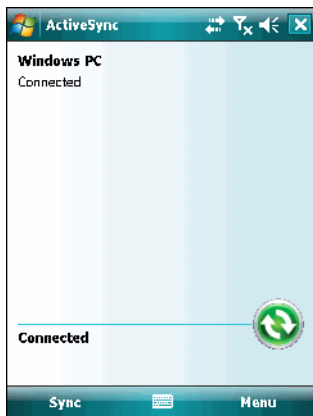

Figure 3-1 ActiveSync Window

2. Tap **Menu > Connections**.
3. Select the connection type from the drop-down list.
4. Tap **OK** to exit the **Connections** window and tap **OK** to exit the **ActiveSync** window.
5. Proceed with installing ActiveSync on the host computer and setting up a partnership.

USB Configuration

To configure the USB connection for ActiveSync:

1. Tap **Start > Settings > System > USBConfig** icon.

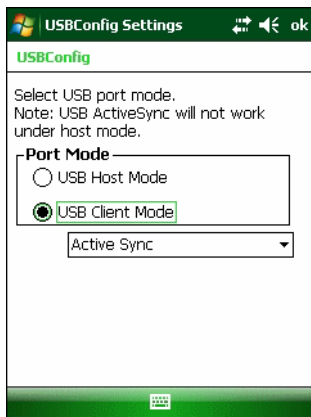

Figure 3-2 USBConfig Window

2. Ensure that the **USB Client Mode** radio button is selected.
3. In the drop-down list, select **ActiveSync**.
4. Tap **Ok**.

Setting Up an ActiveSync Connection on the Host Computer

To start ActiveSync:

1. Select **Start > Programs > Microsoft ActiveSync** on the host computer. The **ActiveSync** Window displays.

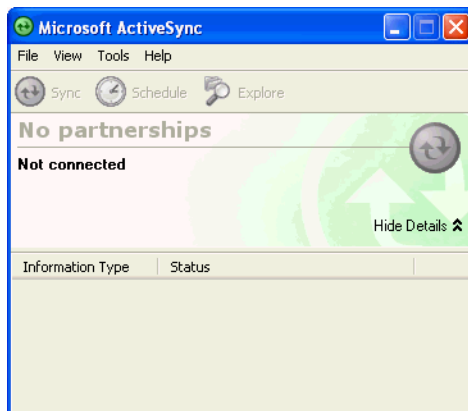

Figure 3-3 ActiveSync Window

✓ **NOTE** Assign each mobile computer a unique device name. Do not try to synchronize more than one mobile computer to the same name.

2. In the **ActiveSync** window, select **File > Connection Settings**. The **Connection Settings** window appears.



Figure 3-4 Connection Settings Window

3. Select the appropriate check box for the type of connection used.
4. Select the **Show status icon in Taskbar** check box.
5. Select **OK** to save any changes made.

Synchronization with a Windows Mobile 6 Device

- ✓ **NOTE** When a mobile computer with Windows Mobile 6 is connected to a host computer and an ActiveSync connection is made, the WLAN radio (if applicable) is disabled. This is a Microsoft security feature to prevent connection to two networks at the same time.

To synchronize with a Windows Mobile 6 device:

1. If the **Get Connected** window does not appear on the host computer, select **Start > All Programs > Microsoft ActiveSync**.

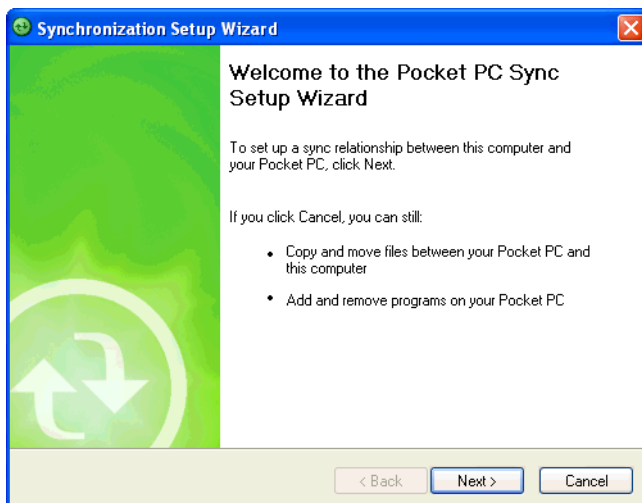

Figure 3-5 Synchronization Setup Wizard Window

2. Click **Next**.

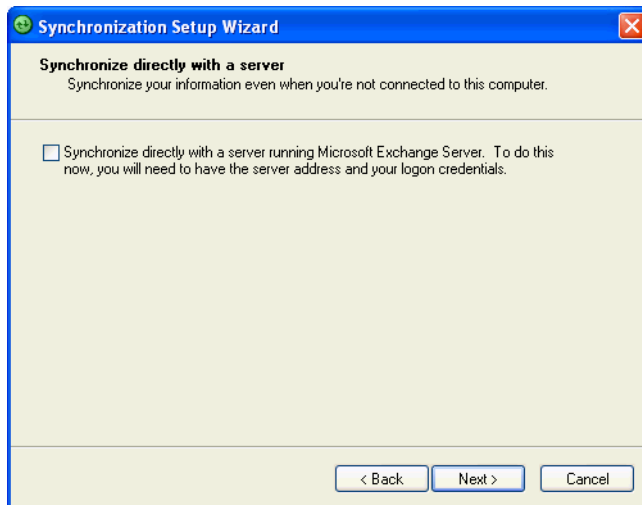

Figure 3-6 *Synchronization Directly With a Server Window*

3. Select the check box to synchronize with a server running Microsoft Exchange if applicable.
4. Click **Next**.

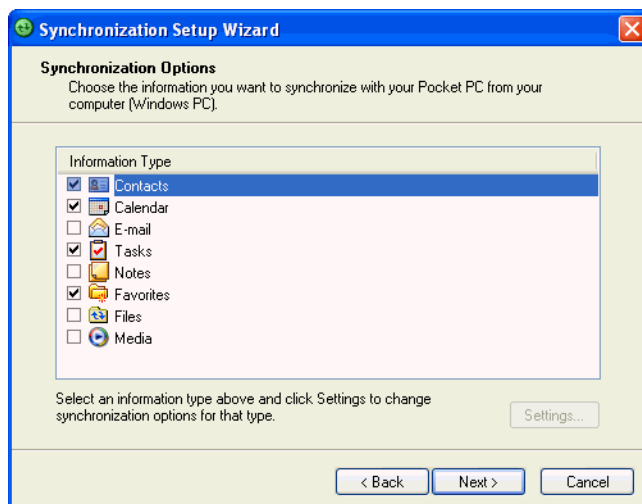

Figure 3-7 *Synchronization Option Window*

5. Select the appropriate settings and click **Next**.

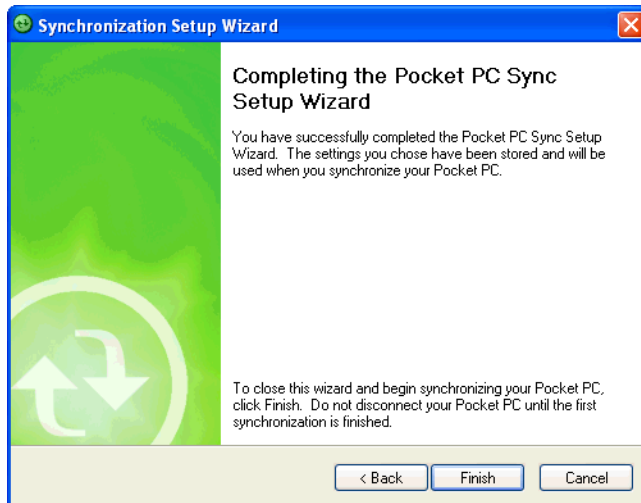

Figure 3-8 Wizard Complete Window

6. Click **Finish**.

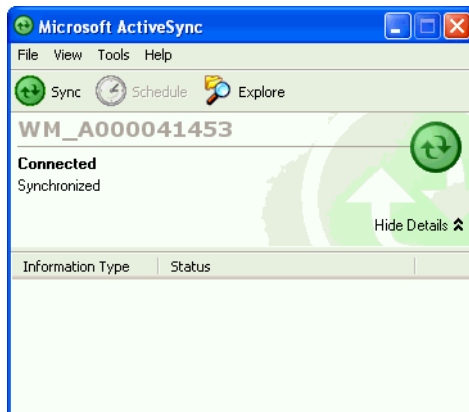

Figure 3-9 ActiveSync Connected Window

During the first synchronization, information stored on the mobile computer is copied to the host computer. When the copy is complete and all data is synchronized, the mobile computer can be disconnected from the host computer.

- ✓ **NOTE** The first ActiveSync operation must be performed with a local, direct connection. Windows Mobile retains partnerships information after a cold boot.

For more information about using ActiveSync, start ActiveSync on the host computer, then see ActiveSync Help.

Chapter 4 Application Deployment for Mobile 6

Introduction

This chapter describes new features in Windows Mobile 6 including new security features, how to package applications, and procedures for deploying applications onto the MC75.

Security

The MC75 implement a set of security policies that determine whether an application is allowed to run and, if allowed, with what level of trust. To develop an application, you must know the security configuration of the device, and how to sign an application with the appropriate certificate to allow the application to run (and to run with the needed level of trust).

Application Security

Application security controls the applications that can run on the MC75.

- Trusted - All applications must be digitally signed by a certificate on the MC75.
- Prompted - User is prompted to allow unsigned applications to run.
- Open - All applications run.

Developers can include their own certificates and provision the device to “trusted.”

Digital Signatures

Digital signatures provide a way to authenticate the author of EXEs, DLLs, and packages. Digitally signed applications give users confidence that an application comes from where they think it comes from. For example, if an end-user downloads an update package from the internet that is digitally signed with Motorola's software certificate, they are assured that the package is authentic and that it was created by Motorola. By enforcing the use of digital signatures, users can also prevent malicious applications from executing on the MC75. For example, users can provision the MC75 to only execute “trusted” applications (digitally signed).

Motorola ships all Windows Mobile 6 based products in an “open” state, which means all signed and unsigned applications should work. However, customers can still reconfigure their MC75s to operate in the “trusted” mode.

This means that only applications signed with a certificate from the Privileged Execution Trust Certificate Store can run.

To support the broadest number of deployments, third-party software developers should perform the following when releasing software for a Windows Mobile 6 devices:

- Sign all their EXEs & DLLs with their private key
- Provide the corresponding public certificate to end-users so that it can be installed into Privileged Execution Trust Certificate Store.

If the software is installed via a .CAB file, developer should also:

- Sign the .CAB file with their private key
- Provide the corresponding public certificate to end-users so that it can be installed into SPC Certificate Store.

Locking Down a Mobile Computer

Like most configuration options in Windows Mobile 6, security settings are set via XML provisioning. For example, to enforce the “trusted” model and only allow applications signed with a privileged certificate to run, use the following provisioning document:

```
<wap-provisioningdoc>
  <characteristic type="SecurityPolicy">
    <!-- Disallow unsigned apps -->
    <parm name= "4102" value= "0"/>

    <!-- No Prompt -->
    <parm name= "4122" value= "1"/>
  </characteristic>
</wap-provisioningdoc>
```

For more information on various security options, refer to the Security Policy Settings topic in the latest Windows Mobile documentation.

Installing Certificates

Use XML provisioning to query and delete certificates from certificate stores. To add a new certificate the Privileged Execution Trust Certificate Store, use the following sample provisioning document:

```
<wap-provisioningdoc>
<characteristic type= "CertificateStore">
<characteristic type= "Privileged Execution Trust Authorities">
<characteristic type= "657141E12FA45786F6A57CA6464032D4B3A55475">
<parm name= "EncodedCertificate" value= "
This is sample text. This is sample text. This is sample text. This is sample text.
This is sample text. This is sample text. This is sample text. This is sample text.
This is sample text. This is sample text. This is sample text. This is sample text. = "/>
</characteristic>
</characteristic>
</characteristic>
</wap-provisioningdoc>
```

To create your own provisioning document with real certificate information:

1. Obtain a certificate from a security provider such as VeriSign.
2. Double-click on the certificate file (.CER) to open it.
3. Click on the *Details* tab and locate the *Thumbprint* field.
4. Copy the contents of the *Thumbprint* field and replace the value in the XML example above.
5. Click the **Copy to File...** button.
6. Click **Next** to start the Certificate Export Wizard.
7. Select *Base-64 encoded X.509 (.CER)* and then click **Next**.
8. Set the File Name to CertOutput.xml and click **Next**.
9. Click **Finish** to export the certificate.
10. Open the exported file, CertOutput.xml, in a text editor (i.e., NotePad).
11. Copy the contents of the file (excluding the first line, last line, and CR/LF) and replace the value of the *"EncodedCertificate"* parameter in the xml example above.

Device Management Security

You can control access to certain device settings and security levels, such as installing applications and changing security settings. Refer to the *Windows Mobile Version 6 Help* file for information on device management security.

Remote API Security

The Remote API (RAPI) enables applications that run on a desktop to perform actions on a remote device. RAPI provides the ability to manipulate the file system on the remote device, including the creation and deletion of files and directories. By default, Motorola ships with RAPI in the restricted mode. Certain tools, such as RAPIConfig,

may not work properly. Refer to the *Windows Mobile Version 6 Help* file for finding information on Remote API security policies.

Packaging

✓ **NOTE** Applications compiled for Windows Mobile 6 are not backward-compatible with previous versions.

Packaging combines an application's executable files into a single file, called a package. This makes it easier to deploy and install an application to the MC75. Package new applications and updates, such as new DLL files, as CAB files, then deploy them to Mobile 6 devices. Refer to the *Microsoft Windows Mobile 6 Help* file for information on CAB files.

Deployment

To install applications onto the MC75, developers package the application and all required files into a CAB file, then load the file onto the MC75 using one of the following options:

- Microsoft ActiveSync 4.1 or higher
- Storage Card
- MSP 3.X
- AirBEAM
- Image Update (for updating the operating system).

Refer to the *Microsoft Windows Mobile 6 Help* file for information on CAB files.

Installation Using ActiveSync

To install an application package:

- Connect the MC75 to a host computer using ActiveSync. See [Chapter 3, ActiveSync](#) for more information.
- Locate the package file on the host computer.
- In ActiveSync on the host computer, open *Explorer* for the MC75.
- Copy the CAB file from the host computer to the \temp directory on the MC75.
- On the MC75, navigate to the \temp directory.
- Tap on the application CAB file. The application installs on the MC75.

Installation Using Storage Card

To install an application package:

- Copy the package CAB file to a storage card using an appropriate storage card reader.
- Install the storage card into the MC75. See [Micro Secure Digital \(microSD\) Card on page 1-10](#) for more information.
- On the MC75, open **File Explorer**.

- Open the *Storage Card* directory.
- Tap the package CAB file. The application installs on the MC75.

Installation Using AirBEAM

The AirBEAM Smart Client provides backward-compatible legacy AirBEAM functionality and backward-compatible legacy MSP 2.x Level 2 Agent functionality.

Refer to the AirBEAM Smart Windows CE Client Product Reference Guide, p/n 72-63060-01, for instructions for AirBEAM Smart client.

MSP 3.X

The MSP 3 Client Software is a set of software components that come pre-installed on the MC75. The MSP 3 Client software consists of the following components:

The RD Client provides support for MSP 3 Staging functionality, provides support for the MSP 3 Legacy Staging process, and provides support for backward-compatible legacy MSP 2.x Legacy Staging functionality.

The MSP 3 Agent provides MSP 3 Provisioning functionality and Control functionality when used with MSP 3.2 Control Edition.

Refer to the Mobility Services Platform 3.2 User's Guide, p/n 72E-100158-06, for instructions for using the Rapid Deployment and MSP3 Agent clients.

Image Update

Windows Mobile 6 contains an Image Update feature that updates all operating system components. All updates are distributed as update packages. Update packages can contain either partial or complete updates for the operating system. Motorola distributes the update packages on the Support Central Web Site, <http://www.motorola.com/enterprisemobility/support>.

To update an operating system component, copy the update package to the MC75 using one of a variety of transports, including ActiveSync, an microSD memory card, or MSP. Then, initiate the update using one of the following methods:

- Double-tap the package file in *File Explorer* (similar to extracting a CAB file)
- Perform a special boot sequence that initiates the update.

✓ **NOTE** The MC75 must have at least 5 MB of free space to perform an OS update.

To initiate an update:

1. Go to the Support Central web site, <http://www.motorola.com/enterprisemobility/support>.
2. Download the appropriate update package.
3. Copy the update package to either the \temp directory on the MC75, or to a storage card.
4. Connect the MC75 to AC power. See [Chapter 2, Accessories](#).
5. Simultaneously press the **Power** button and the **1** and **9** keys.
6. Immediately, as soon as the device starts to boot and before the splash screen is visible, press and hold the right scan button.

7. The Update Loader application first looks for a file on a storage card. If it does not find it, it looks in the \temp directory.
When it finds the appropriate file, it loads the package onto the MC75. A progress bar displays until the update completes.
8. The MC75 re-boots.
9. The calibration screen appears.

✓ **NOTE** When initiating an update via a boot sequence, the update loader looks for updates first on the root of an installed microSD card and then in the \temp folder on the MC75's persistent storage volume. A response file, pkgs.lst, indicates which files to update. In most cases, Motorola provides this pkgs.lst file with the update and you should only modify it when updating a splash screen partition. See [Creating a Splash Screen](#) for more information.

Creating a Splash Screen

Use a bitmap file to create a customized splash screens for the MC75. Use Image Update with a bitmap file, rather than a package file, to update the splash screen.

To create a custom splash screen:

1. Create a .bmp file using a graphic program with the following specifications:
 - Size: 592 x 480.
 - Colors: 16 bits per pixel (65536 colors) for color displays.
2. Modify the bitmap file and save.

To load the splash screen on the MC75:

1. Create a text file named pkgs.lst which contains the name of the bmp file. For example, *mysplash.bmp*.
2. Copy the bmp file and the pkgs.lst file to one of the following:
 - SD card root directory
 - MC75's \temp directory
 - MC75's \Windows directory.
3. If using an SD card, insert the SD card into the MC75.
4. Perform a cold boot.
5. Press the trigger or side scan button for 5 seconds while booting to invoke the Update Loader and install the splash screen.

XML Provisioning

To configure the settings on an MC75, use XML provisioning. To install an XML provisioning file on the MC75, create a Cabinet Provisioning File (CPF). A CPF file is similar to a CAB file and contains just one file: _setup.xml. Like a CAB file, the CPF extension is associated with WCELoad.EXE. Opening a CPF extracts the XML code and uses it to provision and configure the MC75. The user receives an e-mail notification indicating success or failure.

XML provisioning provides the ability to configure various features of the MC75 (i.e., registry and file system). However, some settings require security privileges. To change registry settings via a CPF file, you must have

certain privileges (roles). Some registry keys require you to simply be an *Authenticated User*, while other registry keys require you to be a *Manager*. Refer to the *Microsoft Windows Mobile 6 Help* file, *Metabase Settings for Registry Configuration Service Provider* section, for the default role settings in Windows Mobile 6.

For those registry settings that require the *Manager* role, the CPF file must be signed with a privileged certificate installed on the device. Refer to the *Microsoft Windows Mobile 6 Help* file and the *Windows Mobile 6 SDK* for instructions and sample test certificates.

Creating an XML Provisioning File

To create a .cpf file:

1. Create a valid provisioning XML file named `_setup.xml` using an XML editor or the tools supplied with Visual Studio 2005. (For example, use the `SampleReg.xml` sample created in the [RegMerge](#) section and rename it `_setup.xml`.) Ensure the file contains the required parameters for the operation. Refer to the *Microsoft Windows Mobile 6 Help* file for information.
2. In the Windows Mobile 6 tools directory on the desktop computer (typically `\Program Files\Windows CE Tools\wce500\Windows Mobile 6 Pocket PC SDK\Tools`), run the `Makecab.exe` utility, using the following syntax to create a .cpf file from the `_setup.xml` file:

```
MakeCab.exe /D COMPRESS=OFF _setup.xml myOutCpf
```



NOTE COMPRESS=OFF is required for backward compatibility with Pocket PC.

3. Optionally, use the `Authenticode` tools to sign the .cpf file.
4. Tap the filename to install.
5. Certain applications and settings require a cold boot to take affect. In these cases, cold boot the MC75. Refer to the *Windows Mobile Version 6 Help* file for more information.

XML Provisioning vs. RegMerge and Copy File

Prior to Windows Mobile 6, Motorola used two drivers (`RegMerge` and `CopyFiles`) to update the registry and to copy files during a cold boot. With Mobile 6, Motorola recommends using XML provisioning instead. `RegMerge` and `CopyFiles` are supported for backward compatibility but Motorola may eliminate support in the future. The following sections provide examples of how `RegMerge` and `CopyFiles` were used, and how to perform the same function using XML provisioning.

RegMerge

`RegMerge.dll` is a built-in driver that allows updating the registry during a clean boot. `RegMerge` runs very early in the boot process and looks for registry files (.reg files) in certain Flash File System folders (i.e., `\Application`) during a clean boot. It then merges the registry changes into the system registry located in RAM.

The following example uses `RegMerge` to set a registry key:

SampleReg.reg

```
[HKEY_LOCAL_MACHINE\Hardware\DeviceMap\Backlight]
"BacklightIntensity"=dword:00000036
```

The following example uses XML provisioning to perform the same task:

SampleReg.xml

```
<wap-provisioningdoc>
  <characteristic type= "Registry">
    <characteristic type= "HKLM\Hardware\DeviceMap\Backlight">
      <parm name= "BacklightIntensity" value= "54" datatype= "integer" />
    </characteristic>
  </characteristic>
</wap-provisioningdoc>
```

CopyFiles

CopyFiles copies files from one folder to another on a clean boot. During a clean boot CopyFiles looks for files with a .CPY extension in the root of the Application FFS partition. These files are text files containing the source and destination for the desired files to copy, separated by ">".

The following example uses CopyFiles to copy a file from the \Application folder to the \Windows folder:

SampleCpy.cpy

```
\Application\example.txt > \Windows\example.txt
```

The following example uses XML provisioning to perform the same task:

SampleCpy.xml

```
<wap-provisioningdoc>
  <characteristic type= "FileOperation">
    <characteristic type= "\Windows" translation= "filesystem">
      <characteristic type= "MakeDir"/>
      <characteristic type= "example.txt" translation= "filesystem">
        <characteristic type= "Copy">
          <parm name= "Source" value= "\Application\example.txt" translation= "filesystem"/>
        </characteristic>
      </characteristic>
    </characteristic>
  </characteristic>
</wap-provisioningdoc>
```

Storage

Mobile 6 contains three types of file storage:

- Random Access Memory (RAM)
- Persistent Storage
- Application folder.

Random Access Memory

Executing programs use RAM to store data. Data stored in RAM is lost upon a warm boot. RAM also included a volatile file storage area called *Cache Disk*.

Volatile File Storage (Cache Disk)

Windows Mobile 6 memory architecture uses persistent storage for all files, registry settings, and database objects to ensure data is retained even after a power failure. Persistent storage is implemented using Flash memory technology which is generally slower than volatile RAM memory. In certain situations the speed of the operation is more important than the integrity of the data. For these situations, Motorola has provided a small volatile File Storage volume, accessed as the *Cache Disk* folder. Disk operations to the *Cache Disk* folder are much faster than to any of the persistent storage volumes, but data is lost across warm boots and power interruptions. Note that a backup battery powers RAM memory, including the *Cache Disk*, when you remove the main battery for a short period of time.

The MC75 uses the *Cache Disk* for temporary data that can be restored from other sources, for example, for temporarily “caching” HTML web pages by a browser or generating formatted files to send to a printer. Both situations benefit from the increased speed of the cache disk, but you can restore the data if needed.

DO NOT use the *Cache Disk* as a method to improve application performance. Analyze applications that perform slower in persistent storage to optimize disk access. Common areas for optimization include minimizing the number of reads and writes to a file, removing unneeded debug logging, and minimizing file flushing or closing files.

Persistent Storage

Windows Mobile 6 protects all data and applications from power-related loss. Because Windows Mobile 6 mounts the entire file system and registry in persistent storage (rather than using RAM), MC75 devices provide a reliable storage platform even in the absence of battery power.

Persistent storage provides application developers with a reliable storage system available through the standard file system and registry APIs. Persistent storage is optimized for large reads and writes; therefore, applications reading and writing data in large chunks tend to outperform those applications reading and writing small blocks of data. Data in persistent storage is lost upon a clean boot.

Persistent storage contains all the directories under the root directory except for Application, Cache Disk, and Storage Card (if a storage card is installed). Persistent storage is approximately 60 MB (formatted).

Application Folder

The Application folder is a super-persistent storage that is persistent even after a clean boot. Accessing data in the Application folder is slower than accessing persistent storage. The Application folder is used for deployment and device-unique data. For example, network profiles can be stored in the Application folder so that connection to the network is available after a cold boot. The Application folder is approximately 20 MB (formatted).

Symbol Configuration Manager

Symbol Configuration Manager (SCM) is a utility that runs on the development computer and is used to create configuration files. These files, when deployed to an MC75, set configuration parameters for that device. The configurable options for a MC75 are defined in an XML file that is available on the Support Central (<http://www.motorola.com/enterprisemobility/support>) for that MC75. SCM is also available on Support Central.

SCM eliminates the potential user errors that occur when manually editing registry settings.

File Types

SCM uses three types of files:

- Symbol Configuration Template (.SCT) files are XML files that define the configurable parameters for a device.
- Registry Configuration Service Provider XML files for device provisioning.
- CAB Provisioning Format (.CPF) file which is a .CAB archive that contains the provisioning XML. This file is downloaded to the MC75 and merged upon a cold boot.

User Interface

SCM's user interface consists of a tree control on the left side of the window which displays all the configuration categories, and a data grid table on the right which displays all the configurable controls for the selected category. [Figure 4-1](#) shows the main window for a device's .sct file.

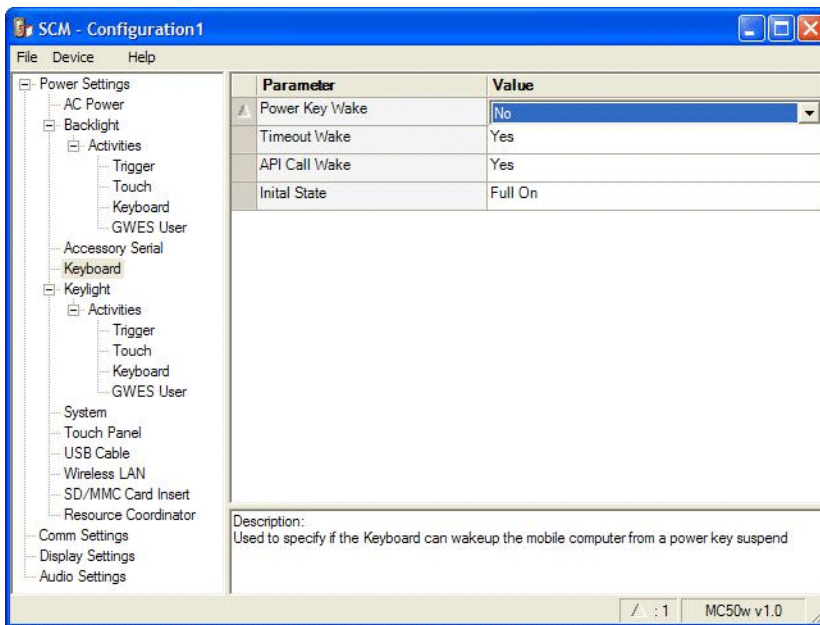

Figure 4-1 Main SCM Window

Menu Functions

Use the main menu to access the program functionality described in [Table 4-1](#).

Table 4-1 SCM Menu Functions

Menu Item	Description
File Menu	
Open Config File	Open a saved configuration file (.SCD).
Save Config Changes	Save changes to the currently loaded configuration file.
Restore All Defaults	Restore all parameter values to the default state. The default values are stored in a Symbol Configuration template file (i.e., MC75w.sct).



Table 4-1 *SCM Menu Functions (Continued)*

Menu Item	Description
Export Changes to .xml	Export the changed parameter values to an XML file.
Export Changes to .cpf	Export the changed parameter values to an CPF file.
Export all to .xml	Export all the parameter values to an XML file.
Export all to .cpf	Export all the parameter values to an CPF file.
Exit	Exit Symbol Configuration Manager.
Device Menu	
Device type	Change the current device type template. Each template (available from the Support Central) must reside in the SCM directory.
Help Menu	
About	Display the <i>About</i> dialog which shows the application version.

Parameter State Indicators

The first column of the data table displays parameter state indicators. The state indicators display one of the states in [Table 4-2](#) for a particular parameter:

Table 4-2 *Parameter Status Indicators*

Icon	Indicator	Description
	Modified	This parameter was changed from its initial factory setting.
	Invalid	This parameter is not valid for the selected device type. This can occur when a configuration file for one type of device is loaded and the device type is changed using the <i>Device</i> menu. Values marked "invalid" are not included in an exported.

Window Status Bar

The SCM status bar found on the bottom right corner of the window contains the items in [Table 4-3](#) from left to right:

Table 4-3 *Window Status Bar Items*

Status Bar Item	Description
Invalid Count	Number of parameters not valid for the selected device.
Modified Count	Number of parameters modified from the factory defaults.
Device Type	Device type - version.

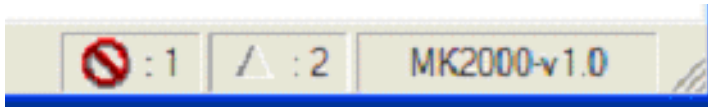

Figure 4-2 *Sample Status Bar*

The sample status bar in [Figure 4-2](#) shows that the current configuration file contains 1 Invalid Parameter and 2 Modified Parameters.

File Deployment

The CPF file created by the SCM export function must be deployed to the MC75.

1. Optionally, use the Authenticode tools to sign the .cpf file.
2. Make the .cpf file read-only, then copy it to the MC75.
3. Tap the filename to install.
4. Certain applications and settings require a cold boot to take affect. In these cases, cold boot the MC75. Refer to the *Windows Mobile Version 6 Help* file for more information.

Enterprise Mobility Developer Kits

The Motorola Enterprise Mobility Developer Kit (EMDK) family of products allows you to write applications that take advantage of the capture, move and manage capabilities of the MC75. Go to the Support Central (<http://www.motorola.com/enterprisemobility/support>) to download the appropriate developer kit.

Chapter 5 MC7506/96 - GSM Configuration

Introduction

This chapter explains how to verify MC7506 and MC7596 service on an Global System for Mobile communications (GSM) wireless network and establish settings.

GSM networks deliver mobile voice and data services, such as Short Message Service (SMS)/Text Messaging, with full roaming capabilities across the world. High-speed Downlink Packet Access (HSDPA) enabled networks offer Internet-based content and packet-based data services. This enables services such as internet browsing, e-mail on the move, powerful visual communications, multimedia messages, and location-based services.

When using the MC75 as a phone, services can include speed dialing, call tracking, voice mail, call forwarding, conference calling, and caller ID, depending on the type of service.

Also use the integrated phone as a modem to connect the MC75 to an ISP or work network. The GSM enabled MC75 can connect to the Internet or work network using Cellular Line, or using the modem specified by the mobile phone service provider.

- ✓ **NOTE** Before using an MC75 on a wireless network, first select a provider, establish a voice and data-enabled service plan, and configure the MC75 (where applicable). Refer to the *MC75 User Guide* for information on how to use the phone and services.

Quick Startup Steps

To use the MC75 for phone and data connections:

1. Install the MC75 main battery. See [Installing the Main Battery on page 1-5](#).
2. Fully charge the main battery and backup battery. See [Charging the Battery on page 1-6](#).
3. Press the red **Power** button to suspend the MC75.
4. Remove the battery.
5. Lift the SIM cover using the stylus tip.

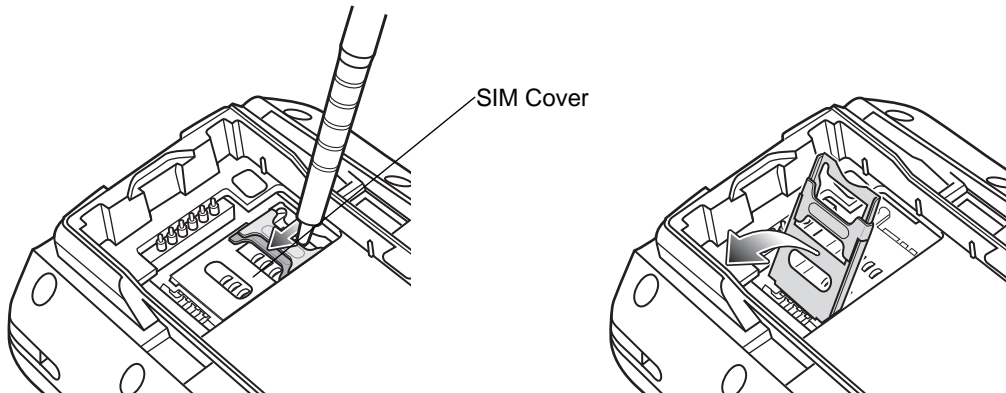

Figure 5-1 Lifting the SIM Cover

6. Insert the SIM card, as shown in [Figure 5-2](#), with the cut edge of the card facing out and the contacts facing down.

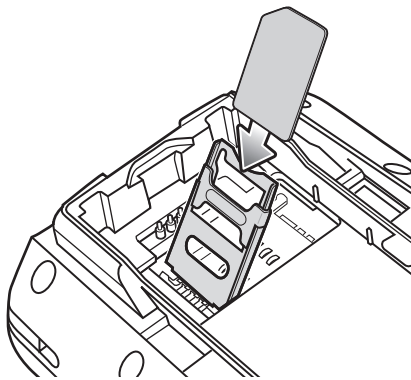

Figure 5-2 Inserting the SIM Card

7. Lower the SIM cover and use the stylus to slide it in place.
 8. Replace the battery and battery cover.
 9. Press the red **Power** button.
 10. Tap **Start > Phone > Menu > Options > Network** tab and verify that the service provider appears in the **Current network:** field. If the service provider name does not appear see [Chapter 8, Maintenance and Troubleshooting](#) for more information.
 11. Make a call to verify connection.
 12. Start the MC75.
 13. Ensure network coverage ([page 5-3](#)).
 14. Configure a data connection ([page 5-4](#)).
- ✓ **NOTE** Data connection configuration is pre-packaged with T-Mobile service. Other service providers may require data connection configuration.
15. Configure settings ([page 5-8](#)).
 16. Use the phone.

MC7506/96 Service Verification

MC7506/96 phone and data services require a live SIM card, obtained from a service provider, installed in the MC75 phone. The SIM card has embedded circuitry on one side of its surface which, when inserted into an MC75 phone, provides phone service. The SIM card provides a phone number, determines the features or services available to the subscriber, and identifies the subscriber to the network.

In addition to SIM card installation, the MC75 may require various settings to operate as a phone with data connection features.

Ensuring Network Coverage

1. Ensure an activated SIM card, from the phone service provider, is installed in the MC75.

✓ **NOTE** The SIM card must be enabled to connect to the network.

2. Verify active phone and data services by tapping  to display the **Phone** dialog. The Carrier name appears in the dialog box.



Figure 5-3 Connectivity Dialog

3. Verify SIM card functionality:
 - a. Tap **Start** > **Settings** > **Personal** tab > **Phone** icon > **Network** tab.

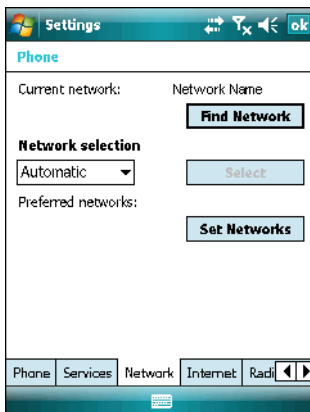

Figure 5-4 Phone Settings Window - Network Tab

- b. Ensure the service provider's network appears in the **Current network:** field.
- c. If the network does not appear, tap **Find Network**. If the network still does not appear, verify that the SIM card was installed correctly. If it was, and no network appears, contact the service provider.

Configuring a Data Connection

A data connection allows Internet access across a wireless network.

To set up a new data connection:

1. Acquire an Access Point Name (APN) from the service provider.
2. Tap **Start > Settings > Connections tab > Connections icon > Tasks tab**.

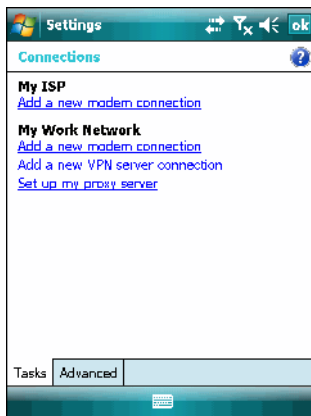

Figure 5-5 Connections Window

3. Under **My ISP** select **Add a new modem connection**.

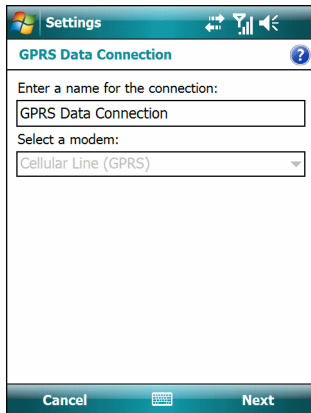

Figure 5-6 Connections Window - Make New Connection

4. Enter a connection name in the *Enter a name for the connection:* text box.
5. Select **Cellular Line (GPRS)** from the **Select a modem:** drop-down list.
6. Tap **Next**.

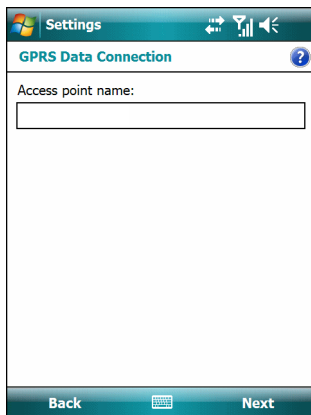

Figure 5-7 Connections Window - Access Point Name

7. Enter the APN from the service provider in the **Access point name:** text box.
8. Tap **Next**.

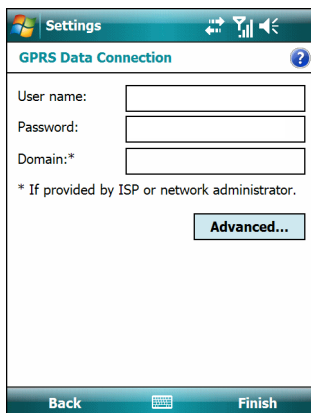

Figure 5-8 Connections Window - User Name & Password

9. Enter a username in the User name text box, if required by the service provider.
10. Enter a password in the Password text box, if required by the service provider.
11. Enter a domain name in the Domain text box, if required by the service provider.
12. Tap **Finish**.
13. Tap **ok** to exit **Connections**.

Establishing a Data Connection

1. Ensure a SIM card is installed in the MC75.
2. Configure a GPRS data connection. See [Configuring a Data Connection on page 5-4](#).
3. Tap the connectivity icon **G**, **E** or **H** at the top of the screen.

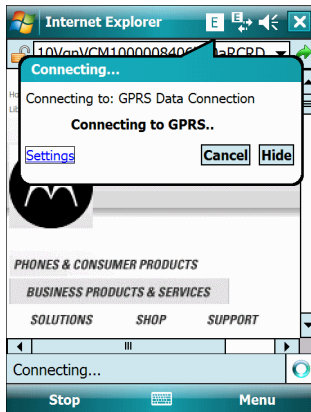

Figure 5-9 Connectivity Dialog Box

4. Tap **Settings**.
5. Tap **Connections** icon.
6. Tap **Managing existing connections**.
7. Tap and hold on the data connection until a menu appears.

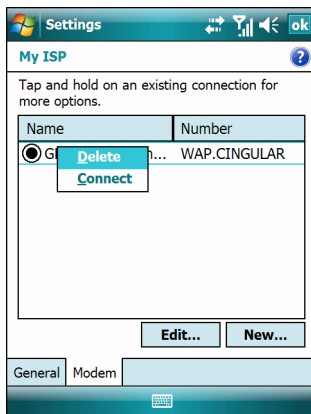

Figure 5-10 Data Connection

8. Select **Connect**.

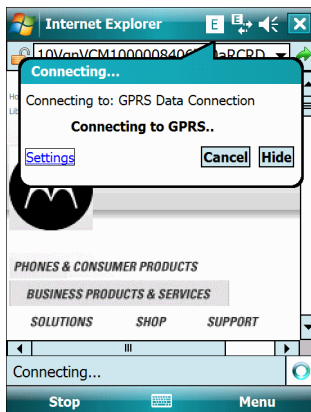

Figure 5-11 Connecting Using GPRS

- If the SIM card is protected with a Personal Identification Number (PIN), a dialog box pops up requesting the appropriate PIN to unlock the SIM card. In this case, enter the PIN and tap **ok**.

✓ **NOTE** Place emergency calls at any time, without entering a PIN or a SIM card.

- When a connection is established, launch **Internet Explorer** to browse the Internet or launch an applicable application.

Ending a Data Connection

To cancel a data connection in progress, tap **Cancel** in the **Connecting...** dialog window.

To end an established data connection:

- Tap, **G**, **E** or **H** to display the **Connectivity** dialog box.

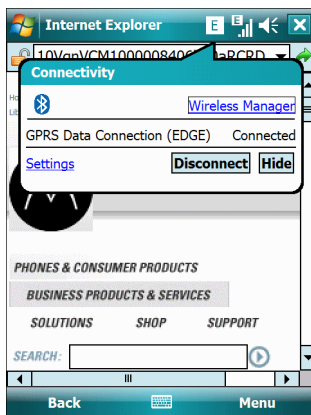

Figure 5-12 Connectivity Dialog Box

- Tap **Disconnect**.

✓ **NOTE** Tapping **Disconnect** during an active data transfer (e.g., downloading a web page) automatically reconnects the connection. You cannot disconnect the connection until the data transfer is complete.

MC7506/96 Settings

Use the **Phone Settings** window to customize settings, such as the ring type and ring tone for incoming calls, security options, and other options depending on the type of service.

Phone

Use the **Phone** tab to customize ring type, ring tone, keypad tone, and security options.

Tap **Start > Settings > Personal tab > Phone icon > Phone tab**

or

Start > Phone > Menu > Options > Phone tab.

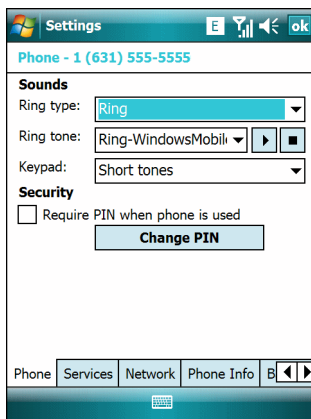

Figure 5-13 MC75 Phone Window - Phone Tab

Sounds

1. **Phone Number** automatically displays on the **Phone** tab when a live SIM card is installed.
2. Select a ring type from the **Ring type:** drop-down list. The ring type changes the way the MC75 rings when you receive an incoming call. Regardless of the ring type selected, a dialog box appears on the MC75's display for incoming calls.
3. Select a ring tone for incoming calls from the **Ring tone:** drop-down list. To hear a sample of the selected ring tone, tap . Tap to end the ring tone.

✓ **NOTE** To use custom .wav, .mid, or .wma files as ring tones, use ActiveSync on the host computer to copy the file to the /Windows/Rings folder on the MC75. Then select the sound from the ring tone list.

4. Select a keypad tone from the **Keypad:** drop-down list. This selection determines the tone that sounds when entering a phone number on the keypad.
Select **Short tones** or **Long tones** to specify the duration of the sound when you press a number on the keypad. Select **Off** to disable tones.

✓ **NOTE** Turning off sounds saves power and prolongs battery life.

Security

Enabling a PIN

✓ **NOTE** Place emergency calls at any time, without requiring a PIN or a SIM card.

To require a PIN when using the phone:

1. From the **Phone** tab ([Figure 5-13](#)), select the **Require PIN when phone is used** check box under **Security**.

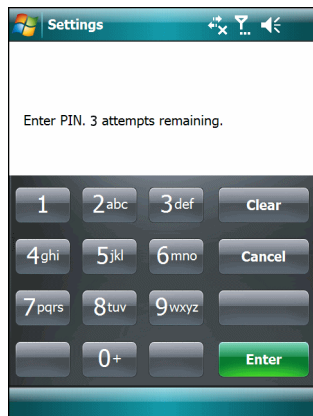

Figure 5-14 Enter PIN

2. Use the touch keypad to enter a four to eight digit PIN.
3. Tap **Enter** to enable the PIN and return to the **Phone** tab.

Changing a PIN



CAUTION If you enter an incorrect PIN, the message “SIM PIN incorrect: Try again” appears. After three consecutive incorrect attempts, the SIM card is blocked. The phone does not allow you to attempt to enter your PIN again and you must obtain a PIN Unblock Key from your service provider.

1. From the **Phone** tab ([Figure 5-13](#)), tap **Change PIN**.
2. Use the touch keypad to enter the current PIN.
3. Tap **Enter**.
4. Use the touch keypad to enter a new four to eight digit PIN.
5. Tap **Enter**.
6. Reenter the new PIN for confirmation and tap **Enter**.
7. Tap **ok** to confirm the change.

Disabling a PIN

1. From the **Phone** tab ([Figure 5-13](#)), deselect the **Require PIN when phone is used** check box.
2. Use the touch keypad to enter the current PIN.
3. Tap **Enter**.

4. Tap **ok** to confirm the change.
5. Tap **ok** to exit settings.

Services

Use the *Services* tab to configure settings for subscribed phone services. For example, block certain types of incoming and/or outgoing calls ([page 5-10](#)), disclose the caller's identity when making outgoing calls ([page 5-11](#)), forward incoming calls to a different phone number ([page 5-11](#)), receive notification of incoming calls when a phone session is in use ([page 5-12](#)), and set up voice mail and short message service ([page 5-12](#)).

1. Tap **Start > Settings > Personal tab > Phone icon > Services** tab.

or

Start > Phone > Menu > Options > Services tab.

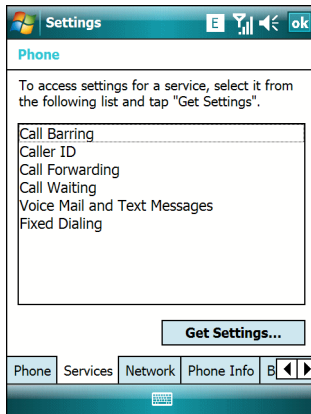

Figure 5-15 MC75 Phone Window - Services Tab

2. Select a service from the list and tap **Get Settings...**
3. Change services settings as follows.

Call Barring (Call Blocking)

Use call barring to block certain types of incoming and/or outgoing calls. Select the type of incoming and/or outgoing calls to block.

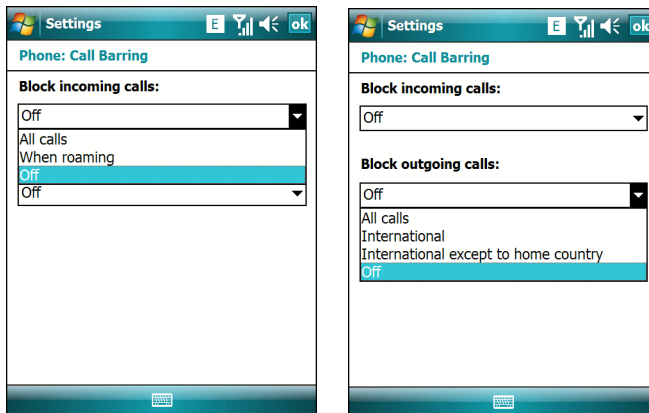

Figure 5-16 Call Barring/Call Blocking

Caller ID

Enable caller ID to reveal the identity of the person making an outgoing call. Select the **Everyone** radio button to always display the caller ID. Select the **No one** radio button to prevent the caller's identity from appearing to others.

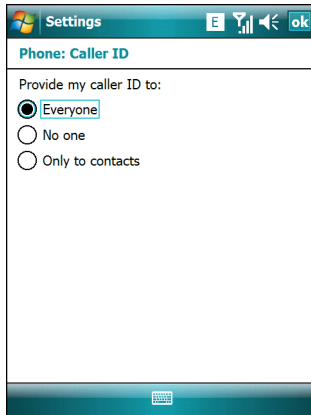

Figure 5-17 Caller ID

Call Forwarding

✓ **NOTE** Call Forwarding may not be available on all networks. Check with your service provider for availability.

Use call forwarding to forward incoming calls to a different phone number.

- To forward all calls to a different phone number:
 - select the **Forward all incoming phone calls** check box.
 - enter the phone number to receive forwarded calls in the **To:** text box.
- To forward incoming calls to a different phone number based on a specific situation, select one or more of the check boxes under **Forward phone calls only if:**
 - **No answer:** enter the phone number to receive forwarded calls only when the phone cannot be answered. Then select a time period from the **Forward after:** drop-down list. Options are 5, 10, 15, 20, 25, and 30 seconds.
 - **Unavailable:** enter the phone number to receive forwarded calls only when the phone is turned off or the user is unreachable.
 - **Busy:** enter the phone number to receive forwarded calls only when the line is busy.

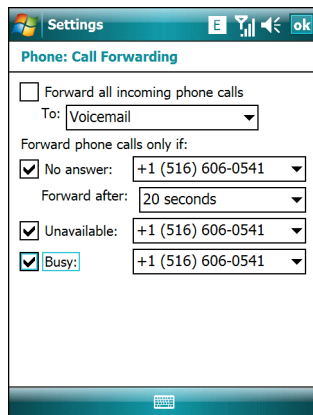

Figure 5-18 *Call Forwarding*

Call Waiting

✓ **NOTE** Call Waiting may not be available on all networks. Check with your service provider for availability.

Call waiting notifies you of an incoming call when the phone is in a phone session. Select the **Notify me** radio button to enable call waiting. Select the **Do not notify me** radio button to disable call waiting.

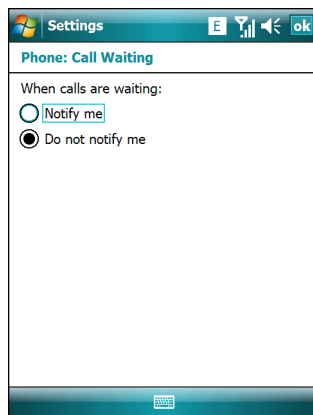

Figure 5-19 *Call Waiting*

Voice Mail and Text Messages

To use voice mail and send short messages, enter the voice mail and/or text message phone number in the appropriate text boxes.

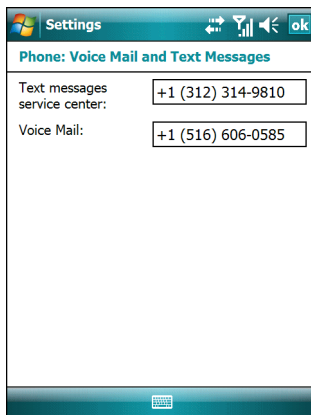

Figure 5-20 *Voice Mail and Text Messages*

Fixed Dialing

Use Fixed Dialing to restrict the phone to dial only the phone number(s) or area code(s) specified in a Fixed Dialing list.

1. Select **Fixed Dialing** and tap **Get Settings**.

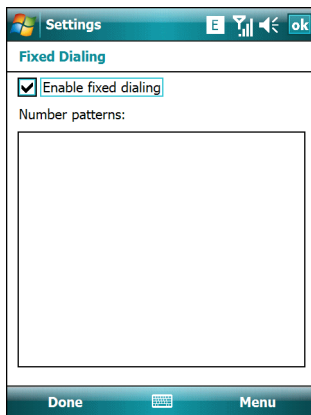

Figure 5-21 *Fixed Dialing Window*

2. Select the **Enable fixed dialing** check box.
3. To add a number to the list, tap **Menu > Add**.
4. Enter the phone number or area code to restrict and tap **Done**.
5. Repeat steps 3 and 4 to add more numbers, and tap **Done** twice when complete.
6. Enter **PIN2** and tap **Done**.

Network

Use the **Network** tab to view available networks, determine the order in which the phone accesses another network if the current network is unavailable, and specify whether to change networks manually or automatically. The current network remains active until it's changed, the signal is lost, or the SIM card is changed.

The network the MC75 currently uses appears in the **Current network:** field at the top of the window.

Changing Networks Manually

1. Tap **Start > Settings > Personal tab > Phone icon > Network tab**

or

Start > Phone > Menu > Options > Network tab.

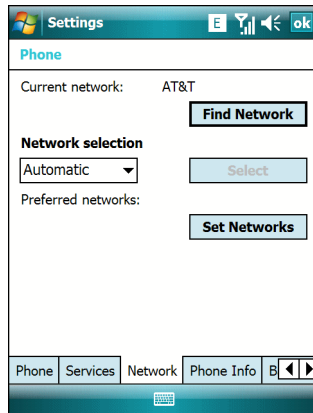

Figure 5-22 MC75 Phone Window - Network Tab

2. From the **Network selection** drop-down list, select **Manual**.

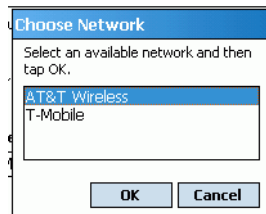

Figure 5-23 Choose Network

3. From the **Choose Network** window, select the network to use.
4. Tap **OK**.

Viewing Available Networks

To view all wireless networks available:

1. Tap **Start > Settings > Personal tab > Phone icon > Network tab**.

or

Start > Phone > Options > Network tab.

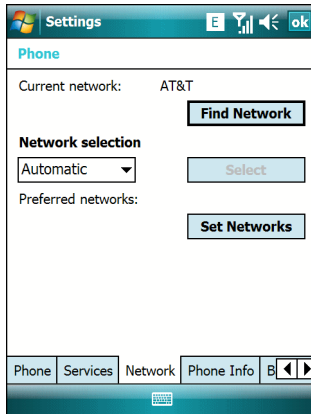

Figure 5-24 MC75 Phone Window - Network Tab

2. Tap Find Network.

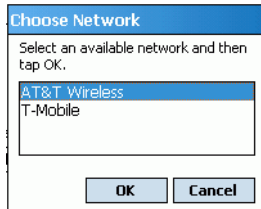

Figure 5-25 Choose Network

3. From the Choose Network window, select the network to use.

4. Tap OK.

Setting Preferred Networks

Set networks in a preferred order of access. Setting preferred networks allows the MC75 to access a second preferred network if the first is unavailable.

1. Tap Start > Settings > Personal tab > Phone icon > Network tab

or

Start > Phone > Menu > Options > Network tab.

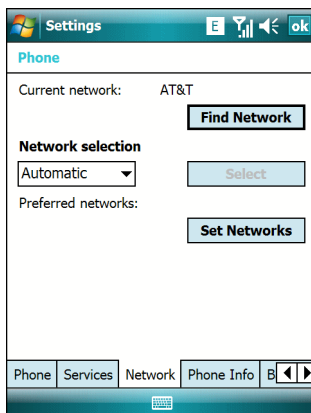

Figure 5-26 MC75 Phone Window - Network Tab

2. Tap **Set Networks** to view all available networks.

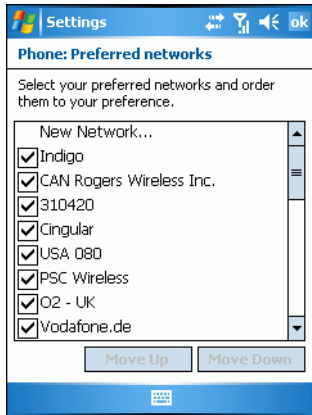

Figure 5-27 Preferred Networks

3. Select the preferred networks by tapping one or more check boxes.
4. Tap **Move Up** and **Move Down**, as necessary, to place the selected networks in the preferred order.
5. Tap **ok** to send the new settings to the network.
6. From the **Network** tab, select **Automatic** from the **Network selection** drop-down list.
7. Tap **ok** to exit settings.

Phone Info

Use the *Phone Info* tab to view hardware and software information about the phone.

1. Tap **Start > Settings > Personal tab > Phone icon > Phone Info** tab

or

Start > Phone > Menu > Options > Phone Info tab.

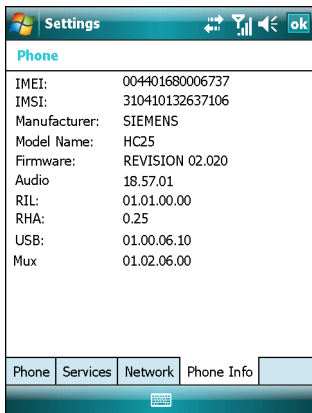

Figure 5-28 MC75 Phone Window - Phone Info Tab

2. Tap **ok** to exit settings.

Network Time Synchronization

The MC75 can be configured to synchronize the clock with the time from the carrier network. A registry key on the MC75 has to be created to enable this feature.

Using a registry editor, navigate to the following:

```
[HKEY_LOCAL_MACHINE\SOFTWARE\Symbol\RIL\PHA\HC25]
```

Create the following key:

```
"SyncSystemTime"=dword:00000001
```

where:

```
dword:0 = disabled
```

```
dword:1 = enabled
```

After setting the registry key, warm boot the MC75.

Enhanced Operator Name String

The MC75 is enabled to download and display the name of the GSM network currently logged in to. Four registry keys on the MC75 have to be edited to disable this feature.

Using a registry editor, navigate to each of the following:

```
[HKEY_LOCAL_MACHINE\Software\Microsoft\RIL]
```

```
[HKEY_LOCAL_MACHINE\Software\Microsoft\RIL\Configurations\GSM_HC25]
```

```
[HKEY_LOCAL_MACHINE\Comm\Cellular\Ril]
```

```
[HKEY_LOCAL_MACHINE\Comm\Cellular\Ril\Configurations\GSM_HC25]
```

Edit the following key:

```
"EonsEnable"=dword:1
```

where:

```
dword:0 = disabled
```

```
dword:1 = enabled (default)
```

After setting the registry key, warm boot the MC75.

Service Provider Name Display

The reg key ("UseServiceProviderName") originally was used to fix the dual-line SIM card issue with value 2. But for the Italian Post, the value 1 should be used to show the virtual carrier name (Poste Mobile).

```
[HKEY_LOCAL_MACHINE\Software\Microsoft\RIL]
```

```
"UseServiceProviderName"=dword:1
```

where:

dword:0 = Display provider name

dword:1 - Display service provider name (default)

dword:2 - Display both provider and service provider name

Chapter 6 MC7508/98 - CDMA Configuration

Introduction

This chapter explains how to activate an MC7508 or MC7598 on a Code Division Multiple Access (CDMA) wireless network and establish settings.

CDMA is a form of wireless multiplexing in which data (e.g., Short Message Service) can be sent over multiple frequencies simultaneously, optimizing the use of available bandwidth. In an CDMA system data is broken into packets, each of which are given a unique identifier, so that they can be sent out over multiple frequencies and then re-built in the correct order by the receiver.

When using the MC75 as a phone, services can include speed dialing, call tracking, voice mail, call forwarding, conference calling and caller ID, depending on the type of service.

The integrated phone in the MC75 can also be used as a modem to connect the MC75 to an ISP or work network. The MC75 can connect to the Internet or work network using Cellular Line, or using the modem specified by the mobile phone service provider.

✓ **NOTE** Before the MC75 can be used on a CDMA wireless network, a provider must be selected, a voice and data-enabled service plan must be established and the MC75 must be properly configured (where applicable).

Refer to the *MC75 User Guide* for information on how to use the phone and services.

Quick Startup Steps

To start using the MC75 for phone and data connections:

1. Install the main battery ([Installing the Main Battery on page 1-5](#)).
2. Charge the main battery and backup battery ([Charging the Battery on page 1-6](#)).
3. Start the MC75 (see [Powering On the MC75 on page 1-8](#)).
4. Activate the phone ([CDMA Phone Activation on page 6-2](#)).
5. Configure settings ([CDMA Settings on page 6-7](#)).
6. Use the phone.

CDMA Phone Activation

CDMA phone service is available from a number of service providers including Sprint®, Verizon Wireless®, Alltel, Bell Mobility and Telus. In addition to service activation for each provider, various settings may be required for the MC75 to operate as a phone. There can be different Activation Wizards depending upon the carrier. Verizon Wireless and Sprint use an automatic activation processes. All other carriers use the manual activation process.

Verizon Wireless Activation

The **Activation Wizard** allows automatic activation. To activate the MC75 using the automated service, the MC75 attempts to call the network on a special number that automatically downloads the phone number and identification codes from the network.

Verizon Wireless automatically downloads the provisioning data. This process is invisible to the user and occurs once, after account activation, during the first data connection attempt.

- ✓ **NOTE** After an MC75 is provisioned for Verizon Wireless service, it is strongly recommended that no other service provider loads are downloaded to the MC75 and no changes are made to any of the provisioning information.

To activate the phone using the Verizon Wireless automated service:

1. Ensure the MC75 is in a strong signal area.
2. The Activation Wizard automatically starts whenever the phone is turned on. If the wizard does not appear, tap **Start > Phone > Menu > Activation Wizard...**

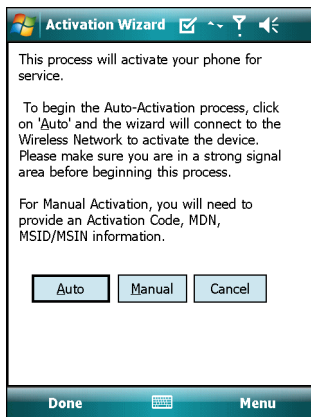

Figure 6-1 Verizon Activation Wizard

3. Tap **Auto** to connect to the Verizon Wireless Network to automate activation. Automated activation provides all required codes and identification numbers over the network. No additional activation setup is required.
4. Tap **Finish** to close the **Activation Wizard**.

- ✓ **NOTE** If activation was not successful, contact the service provider.

5. The phone can be used in approximately four hours, depending on the network provider load.

Sprint Activation

To activate the phone using Sprint service:

1. Ensure the MC75 is in a strong signal area.
2. The Activation Wizard automatically starts whenever the phone is turned on. If the wizard does not appear, tap **Start > Phone > Menu > Activation Wizard...** .

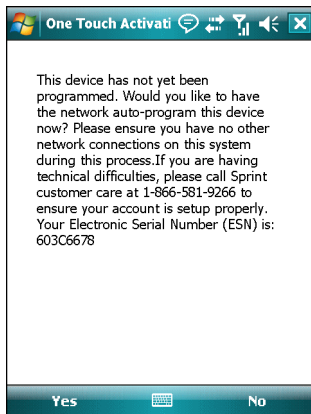

Figure 6-2 One Touch Activation Wizard

3. Tap **Yes**. Automatic provisioning begins.

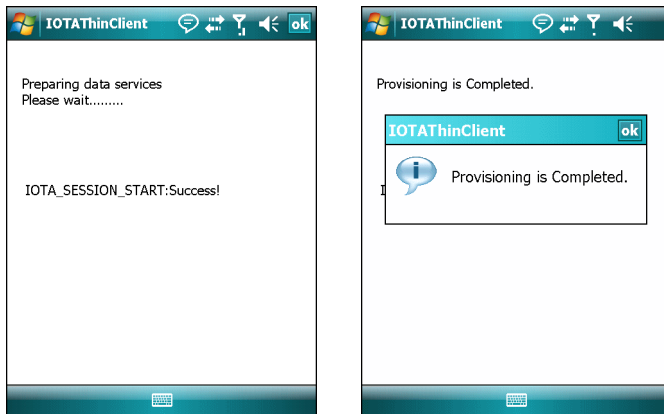

Figure 6-3 Provisioning in Process

✓ **NOTE** If activation was not successful, contact the service provider.

4. Tap OK to close the application.

Manual Activation

To activate the phone:

1. Ensure the MC75 is in a strong signal area.
2. The Activation Wizard automatically starts whenever the phone is turned on. If the wizard does not appear, tap **Start > Phone > Menu > Activation Wizard...** .

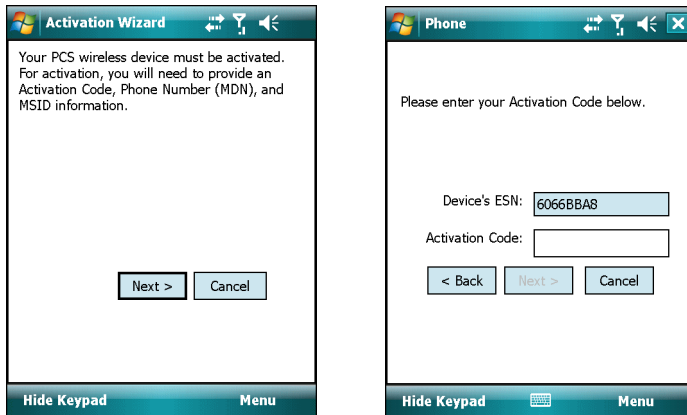

1. Tap **Manual**.
2. Enter the 6-digit activation code from your service provider.
3. Tap **Next >**.

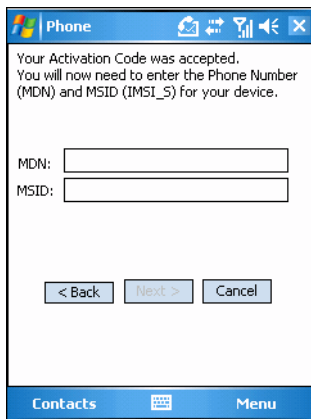

Figure 6-4 Activation Wizard - MDN and MSID

4. Enter the MDN and MSID. The MDN and MSID are the area code and phone number received from the service provider.
5. Tap **Next >**.

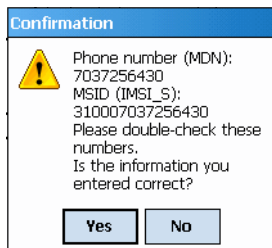

Figure 6-5 Activation Wizard - Confirmation

6. Verify that the MDN and MSIN numbers entered are correct, tap **Yes** to confirm.

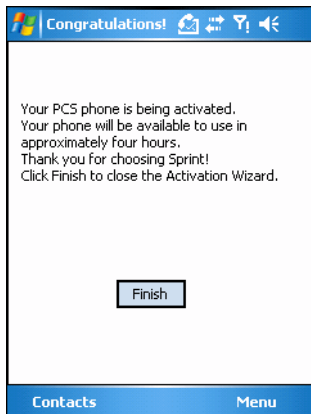

Figure 6-6 Activation Wizard - Activation Complete

✓ **NOTE** If activation was not successful, contact the service provider.

7. Tap **Finish** to complete activation. The phone can be used in approximately four hours.

Activation Test

Approximately four hours after activation is completed, test the service.

1. Tap **Start > Phone**.

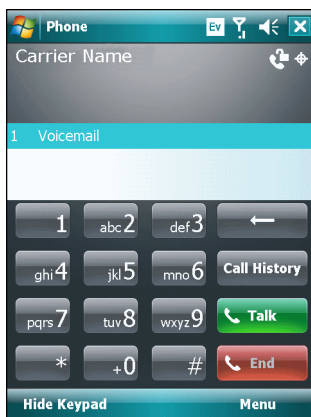

Figure 6-7 Phone Window - Example

2. Ensure the carrier name displays on the window.
3. Make a voice call to ensure activation was successful.

✓ **NOTE** If activation was not successful, contact the service provider.

Establishing a Data Connection

- ✓ **NOTE** Ensure that you have data service activated with your service provider.

A data connection allows Internet access across a wireless network. Data connection is pre-packaged with service accounts.

To verify active data service:

1. Tap **Start > Internet Explorer**.
2. In the address bar, enter a URL for a web site.
3. Tap  to display the **Connectivity** dialog. The dialog box displays the data connection information.

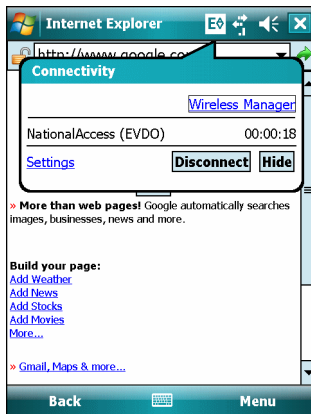

Figure 6-8 Data Connection

CDMA Settings

Use the **Phone Settings** window to customize CDMA phone settings, such as the ring type and ring tone for incoming calls and other options depending on the type of service.

Phone

Use the **Phone** tab to customize ring type, ring tone and keypad tone when entering phone numbers.

1. Tap **Start > Settings > Personal** tab > **Phone** icon > **Phone** tab.

or

Start > Phone > Menu > Options > Phone tab.

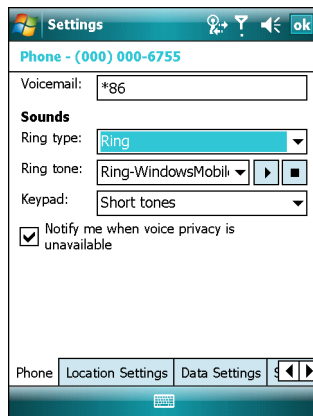

Figure 6-9 Phone Window - Phone Tab

2. Phone and voicemail phone numbers automatically display when phone service is activated.
3. Select a ring type from the **Ring type**: drop-down list. The ring type changes the way the MC75 rings to notify the user of an incoming call. Regardless of the ring type selected, a dialog box appears on the display for incoming calls.
4. Select a ring tone for incoming calls from the **Ring tone**: drop-down list. To hear a sample of the selected ring tone, tap . Tap to end the ring tone.

✓ **NOTE** To use custom .wav, .mid or .wma files as ring tones, use ActiveSync on the host PC to copy the file to the /Windows/Rings folder on the MC75. Then, select the sound from the ring tone list.

5. Select a keypad tone from the **Keypad**: drop-down list. This selection determines the tone that sounds when entering a phone number on the keypad.
 - a. Select **Short Tones** for a tone that sounds only for one or two seconds.
 - b. Select **Long Tones** for a continuous sound for as long as the number on the keypad is pressed.
 - c. Select **Off** to disable tones.
6. Tap **Other Settings...** to set additional sounds and notifications for the MC75.
7. Select the **Notify me when voice privacy is unavailable** check box to receive a message when dialing.

8. Tap **ok** to exit settings.



NOTE Turning off sounds saves power and prolongs battery life.

Location Settings

Use the **Location** tab to allow the network to detect the position of the MC7595's radio.

1. Tap **Start > Settings > Personal tab > Phone icon > Location Settings** tab.

or

Start > Phone > Menu > Options > Location Settings tab.

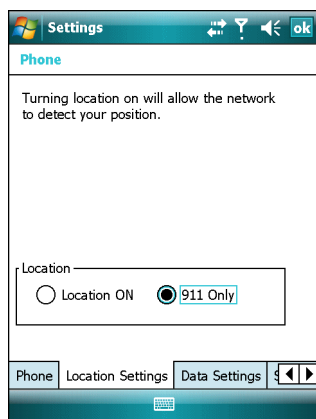

Figure 6-10 Phone Window - Location Tab (Typical)

2. Select the **Location ON** radio button to allow the network to detect the position of the MC75's radio.

or

Select the **911 Only** button to turn off location detection, hiding the location of the radio from all but 911 emergency service.

3. Tap **ok** to confirm **Location ON** or **911 Only**.
4. Tap **ok** again to exit settings.

Data Settings

Sprint Data Settings

Use the **Data Settings** tab to reset connection settings for PCS Vision and update the Vision profile, and to start IP-based Over-The-Air (IOTA) provisioning.

1. Tap **Start > Settings > Personal tab > Phone icon > Data Settings** tab.

or

Start > Phone > Menu > Options > Data Settings tab.

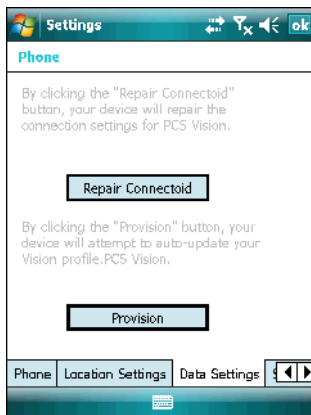

Figure 6-11 Phone Window - Sprint Data Tab

2. Tap **Repair Connectoid** to reset PCS Vision connection settings.

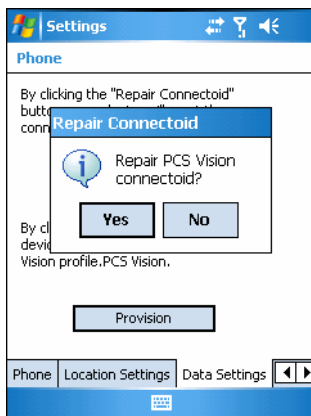

Figure 6-12 Reset Connection Settings Dialog

3. Tap **Yes**.

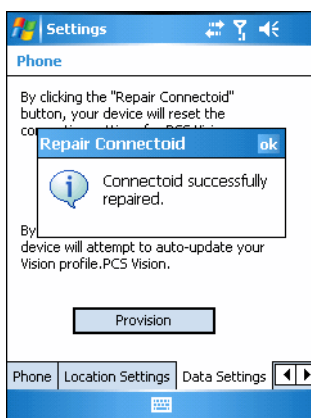

Figure 6-13 Reset Connection Completed Dialog

4. Tap **ok**.
5. Tap **Provision** to manually start IP-based Over-The-Air (IOTA) provisioning.

IOTA is used to provision various data elements such as Wireless Application Protocol (WAP) configuration parameters and roaming lists to the MC75 over-the-air. It is also used to provision other elements such as applications and firmware.

6. Tap **ok** to exit.

Verizon Wireless Data Settings

Use the **Data** tab to reset connection settings for national access.

1. Tap **Start > Settings > Personal tab > Phone icon > Data Settings** tab.

or

Start > Phone > Menu > Options > Data Settings tab.

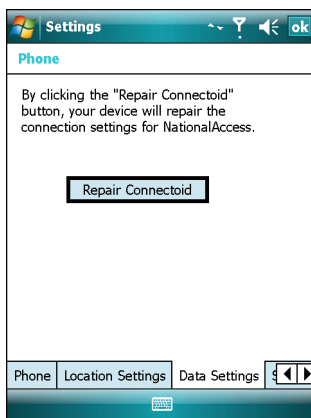

Figure 6-14 Phone Window - Verizon Data Tab

2. Tap **Repair Connectoid** to reset connection settings for National Access.
3. Tap **Yes**.
4. Tap **ok**.
5. Tap **ok** to exit settings.

Additional Service provider Data Settings

Use the *Data* tab to reset connection settings for the 3G connection.

1. Tap **Start > Settings > Personal tab > Phone icon > Data Settings** tab.

or

Start > Phone > Menu > Options > Data Settings tab.

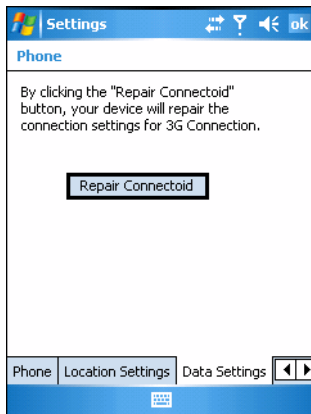

Figure 6-15 Phone Window - Data Tab

2. Tap **Reset Connection** to reset connection settings for the 3G connection.
3. Tap **Yes**.
4. Tap **ok**.
5. Tap **ok** to exit settings.

System Settings

Use the **System Settings** tab to select roaming options.

Tap **Start > Settings > Personal tab > Phone icon > System Settings** tab.

or

Tap **Start > Phone > Menu > Options > System** tab.

Sprint System

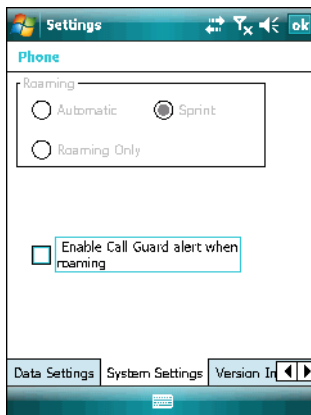

Sprint

Figure 6-16 Phone Window - System Settings Tab - Sprint

1. Roaming:

- Select the **Automatic** radio button to allow the phone to automatically seek a roaming network where the Sprint Nationwide PCS Network is not available. Automatic roaming is available where Sprint implemented roaming with other wireless carriers.
 - Select the **Sprint** radio button to allow the phone to automatically seek a roaming network within the Sprint Nationwide PCS Network only.
 - Select **Roaming Only** radio button to allow the phone to automatically seek a roaming network.
2. Select the **Enable Call Guard alert when roaming** check box to control roaming charges by receiving a reminder when a roaming call is made or received. When a roaming call is made or received, **Roaming rate applies for this call. Press OK to dial.** appears on the MC75 display screen.
 3. Tap **ok** to exit settings.

Verizon System

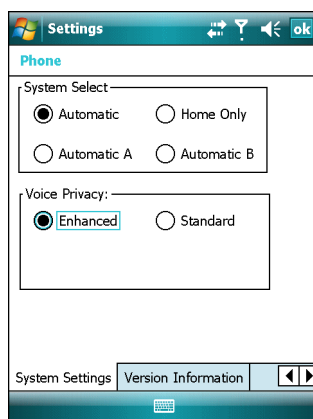

Figure 6-17 Phone Window - System Settings Tab - Verizon

1. System Select allows the user to change the system roaming preference of the radio in order to control the type of network the radio can lock onto for service.
 - Select the **Automatic** radio button to allow the radio to lock onto networks based on the provisioning of the radio.
 - Select the **Automatic A** or **Automatic B** radio button to allow the radio to lock onto an A or B network carrier, respectively, if no other network can be found that matches the radio's provisioning.
 - Select the **Home Only** radio button to prevent the radio from locking on any network that is considered a roaming network.
2. Voice Privacy allows the user to enable or disable voice privacy.
 - Select the **Enhanced** radio button to trigger the network to use voice privacy whenever the current network supports it. When in a call, if network privacy is being used, a voice privacy icon is displayed in the user interface.
 - Select the **Standard** radio button to prevent voice privacy from being used when in a call.
3. Tap **ok** to exit settings.

Additional Service Provider System

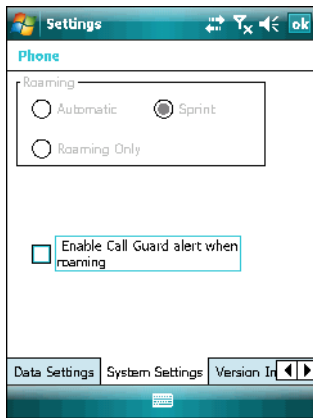

Figure 6-18 Phone Window - System Settings Tab - Additional

1. System Select allows the user to change the system roaming preference of the radio in order to control the type of network the radio can lock onto for service.
 - Select the **Automatic** radio button to allow the radio to lock onto networks based on the provisioning of the radio.
 - Select the **Home Only** radio button to prevent the radio from locking on any network that is considered a roaming network.
2. Voice Privacy allows the user to enable or disable voice privacy.
 - Select the **Enhanced** radio button to trigger the network to use voice privacy whenever the current network supports it. When in a call, if network privacy is being used, a voice privacy icon is displayed in the user interface.
 - Select the **Standard** radio button to prevent voice privacy from being used when in a call.
3. Tap **ok** to exit settings.

Version Information

Use the **Version Information** tab to view phone number and version information.

1. Tap **Start > Settings > Personal tab > Phone icon > Version Information tab**.
or
Start > Phone > Menu > Options > Version Information tab.

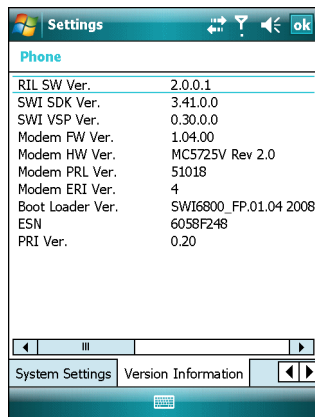

Figure 6-19 Phone Window - Version Information Tab

2. Tap **ok** to exit settings.

Services

Depending on the type of subscribed phone services, the following services may be available: call barring, caller ID, call forwarding, call waiting, voice mail and Short Message Service (SMS).

Call Barring (Call Blocking)

Call barring blocks certain types of incoming and/or outgoing calls. This service is setup when an account is opened with the service provider.

Caller ID

Caller ID provides a way for people to know the identity of the person making an outgoing call. To disable caller ID and block the outgoing phone number:

1. Enter *67 on the phone keypad.
2. Enter the phone number to call.

✓ **NOTE** *67, followed by the phone number, must be entered on a call-by-call basis to block the outgoing phone number.

Call Forwarding

✓ **NOTE** Call Forwarding may not be available on all networks. Check with your service provider for availability.

Use call forwarding to forward incoming calls to a different phone number. To enable call forwarding and send calls to another phone number:

1. Enter *72 on the phone keypad.
2. Enter the area code and phone number of the phone to accept the forwarded calls.
3. Tap **Talk**.
4. A beep sounds indicating activation.
5. Tap **End**.

To disable call forwarding:

1. Enter *73 (Verizon Wireless) on the phone keypad.
2. Tap **Talk**.
3. A beep sounds indicating deactivation.
4. Tap **End**.

Call Waiting

✓ **NOTE** Call Waiting may not be available on all networks. Check with your service provider for availability.

Call waiting notifies the user of an incoming call when the phone is in a phone session. This service is setup when an account is opened with the service provider.

Voice Mail and Short Message Service (SMS)

This service is setup when an account is opened with the service provider.

Network Time Synchronization

The MC75 can be configured to synchronize the clock with the time from the carrier network. A registry key on the MC75 has to be created to enable this feature.

Using a registry editor, navigate to the following:

```
[HKEY_LOCAL_MACHINE\SOFTWARE\Symbol\RL\RHAMC5725]
```

Create the following key:

```
"SyncSystemTime"=dword:00000001
```

where:

dword:0 = disabled

dword:1 = enabled

After setting the registry key, warm boot the MC75.

Chapter 7 Wireless Applications

Introduction

Wireless Local Area Networks (LANs) allow mobile computers to communicate wirelessly and send captured data to a host device in real time. Before using the MC75 on a WLAN, the facility must be set up with the required hardware to run the wireless LAN and the MC75 must be configured. Refer to the documentation provided with the access points (APs) for instructions on setting up the hardware.

802.11d is enabled by default. When enabled, the AP must be configured the same in order to connect.

To configure the MC75, a set of wireless applications provide the tools to configure and test the wireless radio in the MC75. Refer to the *Wireless Fusion Enterprise Mobility Suite User Guide for Version X.XX* for information on configuring wireless profiles; where X.XX is the Fusion version. Go to <http://www.motorola.com/enterprisemobility/manuals> for the latest version of this guide. See [Software Versions on page xiv](#) to determine the Fusion version on the MC75.

The **Wireless Application** menu on the task tray provides the following wireless applications:

- Find WLANs
- Manage Profiles
- Manage Certs
- Manage PACs
- Options
- Wireless Status
- Wireless Diagnostics
- Log On/Off
- Enable/Disable Radio.

Tap the **Signal Strength** icon to display the **Wireless Applications** menu.

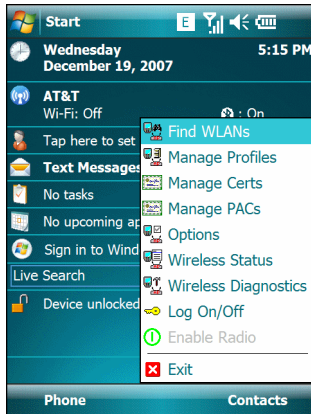









Figure 7-1 *Wireless Applications Menu*

Signal Strength Icon

The **Signal Strength** icon in the task tray indicates the MC75's wireless signal strength as follows:

Table 7-1 *Signal Strength Icons Descriptions*

Icon	Status	Action
	Excellent signal strength	Wireless LAN network is ready to use.
	Very good signal strength	Wireless LAN network is ready to use.
	Good signal strength	Wireless LAN network is ready to use.
	Fair signal strength	Wireless LAN network is ready to use. Notify the network administrator that the signal strength is only "Fair".
	Poor signal strength	Wireless LAN network is ready to use. Performance may not be optimum. Notify the network administrator that the signal strength is "Poor".
	Out-of-network range (not associated)	No wireless LAN network connection. Notify the network administrator.
	No wireless LAN network card detected	No wireless LAN network card detected, Wireless LAN disabled or radio disabled. Notify the network administrator.
None	No wireless LAN network card detected or Wireless LAN disabled	No wireless LAN network card detected or Wireless LAN disabled or radio disabled. Notify the network administrator.

Turning the WLAN Radio On and Off

To turn the WLAN radio off tap the **Signal Strength** icon and select **Disable Radio**.

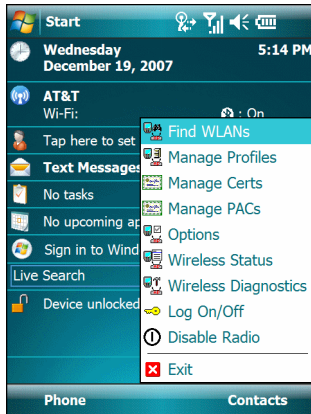

Figure 7-2 *Disable Radio*

To turn the WLAN radio on tap the **Signal Strength** icon and select **Enable Radio**.

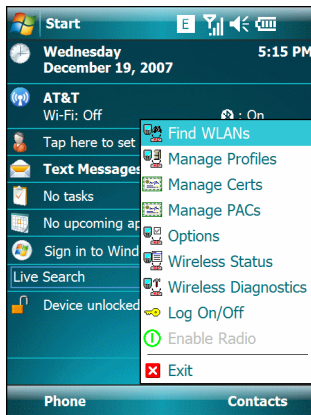

Figure 7-3 *Enable Radio*

Chapter 8 Maintenance and Troubleshooting

Introduction

This chapter includes instructions on cleaning and storing the MC75, and provides troubleshooting solutions for potential problems during MC75 operation.

Maintaining the MC75

For trouble-free service, observe the following tips when using the MC75:

- Do not scratch the screen of the MC75. When working with the MC75, use the supplied stylus or plastic-tipped pens intended for use with a touch-sensitive screen. Never use an actual pen or pencil or other sharp object on the surface of the MC75 screen.

Motorola recommends using a screen protector, p/n KT-67525-01R.

- The touch-sensitive screen of the MC75 is glass. Do not drop the MC75 or subject it to strong impact.
- Protect the MC75 from temperature extremes. Do not leave it on the dashboard of a car on a hot day, and keep it away from heat sources.
- Do not store or use the MC75 in any location that is dusty, damp, or wet.
- Use a soft lens cloth to clean the MC75. If the surface of the MC75 screen becomes soiled, clean it with a soft cloth moistened with a diluted window-cleaning solution.
- Periodically replace the rechargeable battery to ensure maximum battery life and product performance. Battery life depends on individual usage patterns.

- A screen protector is applied to the MC75. Motorola recommends using this to minimize wear and tear. Screen protectors enhance the usability and durability of touch screen displays. Benefits include:
 - Protection from scratches and gouges
 - Durable writing and touch surface with tactile feel
 - Abrasion and chemical resistance
 - Glare reduction
 - Keeping the device's screen looking new
 - Quick and easy installation.

Battery Safety Guidelines

- The area in which the units are charged should be clear of debris and combustible materials or chemicals. Particular care should be taken where the device is charged in a non commercial environment.
- Follow battery usage, storage, and charging guidelines found in the user's guide.
- Improper battery use may result in a fire, explosion, or other hazard.
- To charge the mobile device battery, the battery and charger temperatures must be between +32°F and +104°F (0°C and +40°C)
- Do not use incompatible batteries and chargers. Use of an incompatible battery or charger may present a risk of fire, explosion, leakage, or other hazard. If you have any questions about the compatibility of a battery or a charger, contact Motorola Enterprise Mobility support.
- For devices that utilize a USB port as a charging source, the device shall only be connected to products that bear the USB-IF logo or have completed the USB-IF compliance program.
- To enable authentication of an approved battery, as required by IEEE1725 clause 10.2.1, all batteries will carry a Motorola hologram. Do not fit any battery without checking it has the Motorola authentication hologram.
- Do not disassemble or open, crush, bend or deform, puncture, or shred.
- Severe impact from dropping any battery-operated device on a hard surface could cause the battery to overheat.
- Do not short circuit a battery or allow metallic or conductive objects to contact the battery terminals.
- Do not modify or remanufacture, attempt to insert foreign objects into the battery, immerse or expose to water or other liquids, or expose to fire, explosion, or other hazard.
- Do not leave or store the equipment in or near areas that might get very hot, such as in a parked vehicle or near a radiator or other heat source. Do not place battery into a microwave oven or dryer.
- Battery usage by children should be supervised.
- Please follow local regulations to promptly dispose of used re-chargeable batteries.
- Do not dispose of batteries in fire.
- Seek medical advice immediately if a battery has been swallowed.
- In the event of a battery leak, do not allow the liquid to come in contact with the skin or eyes. If contact has been made, wash the affected area with large amounts of water and seek medical advice.
- If you suspect damage to your equipment or battery, contact Motorola Enterprise Mobility support to arrange for inspection.

Cleaning



CAUTION Always wear eye protection.

Read warning label on compressed air and alcohol product before using.

If you have to use any other solution for medical reasons please contact Motorola for more information.



WARNING! Avoid exposing this product to contact with hot oil or other flammable liquids. If such exposure occurs, unplug the device and clean the product immediately in accordance with these guidelines.

Materials Required

- Alcohol wipes
- Lens tissue
- Cotton tipped applicators
- Isopropyl alcohol
- Can of compressed air with a tube.

Cleaning the MC75

Housing

Using the alcohol wipes, wipe the housing including keys and in-between keys.

Display

The display can be wiped down with the alcohol wipes, but care should be taken not to allow any pooling of liquid around the edges of the display. Immediately dried the display with a soft, non-abrasive cloth to prevent streaking.

Scanner Exit Window

Wipe the scanner exit window periodically with a lens tissue or other material suitable for cleaning optical material such as eyeglasses.

Connector

1. Remove the main battery from mobile computer. See [Installing the Main Battery on page 1-5](#).
2. Close battery door.
3. Dip the cotton portion of the cotton tipped applicator in isopropyl alcohol.
4. Rub the cotton portion of the cotton tipped applicator back-and-forth across the connector on the bottom of the MC75. Do not leave any cotton residue on the connector.
5. Repeat at least three times.
6. Use the cotton tipped applicator dipped in alcohol to remove any grease and dirt near the connector area.
7. Use a dry cotton tipped applicator and repeat steps 4 through 6.

8. Spray compressed air on the connector area by pointing the tube/nozzle about ½ inch away from the surface. CAUTION: Do not point nozzle at yourself and others, ensure the nozzle or tube is away from your face.
9. Inspect the area for any grease or dirt, repeat if required.

Cleaning Cradle Connectors

To clean the connectors on a cradle:

1. Remove the DC power cable from the cradle.
2. Dip the cotton portion of the cotton tipped applicator in isopropyl alcohol.
3. Rub the cotton portion of the cotton tipped applicator along the pins of the connector. Slowly move the applicator back-and-forth from one side of the connector to the other. Do not let any cotton residue on the connector.
4. All sides of the connector should also be rubbed with the cotton tipped applicator.
5. Spray compressed air in the connector area by pointing the tube/nozzle about ½ inch away from the surface. CAUTION: do not point nozzle at yourself and others, ensure the nozzle or tube is pointed away from your face.
6. Ensure that there is no lint left by the cotton tipped applicator, remove lint if found.
7. If grease and other dirt can be found on other areas of the cradle, use lint free cloth and alcohol to remove.
8. Allow at least 10 to 30 minutes (depending on ambient temperature and humidity) for the alcohol to air dry before applying power to cradle.

If the temperature is low and humidity is high, longer drying time is required. Warm temperature and dry humidity requires less drying time.

Cleaning Frequency

The cleaning frequency is up to the customer's discretion due to the varied environments in which the mobile devices are used. They may be cleaned as frequently as required. However when used in dirty environments it may be advisable to periodically clean the scanner exit window to ensure optimum scanning performance.

Troubleshooting

MC75

Table 8-1 Troubleshooting the MC75

Problem	Cause	Solution
MC75 does not turn on.	Lithium-ion battery not charged.	Charge or replace the lithium-ion battery in the MC75.
	Lithium-ion battery not installed properly.	Ensure battery is installed properly. See Installing the Main Battery on page 1-5 .
	System crash.	Perform a warm boot. If the MC75 still does not turn on, perform a cold boot. See Resetting the MC75 on page 1-8 .
Rechargeable lithium-ion battery did not charge.	Battery failed.	Replace battery. If the MC75 still does not operate, perform a warm boot, then a cold boot. See Resetting the MC75 on page 1-8 .
	MC75 removed from cradle while battery was charging.	Insert MC75 in cradle. The 3600 mAh battery fully charges in less than six hours.
	Extreme battery temperature.	Battery does not charge if ambient temperature is below 0°C (32°F) or above 40°C (104°F).
Cannot see characters on display.	MC75 not powered on.	Press the Power button.
During data communication, no data transmitted, or transmitted data was incomplete.	MC75 removed from cradle or disconnected from host computer during communication.	Replace the MC75 in the cradle, or reattach the communication cable and re-transmit.
	Incorrect cable configuration.	See the system administrator.
	Communication software was incorrectly installed or configured.	Perform setup. Refer to the <i>MC75 Integrator Guide</i> for details.
No sound.	Volume setting is low or turned off.	Adjust the volume. Adjust the volume. Refer to the <i>MC75 User Guide</i> .

Table 8-1 Troubleshooting the MC75 (Continued)

Problem	Cause	Solution
MC75 shuts off.	MC75 is inactive.	The MC75 turns off after a period of inactivity. If the MC75 is running on battery power, set this period from 1 to 5 minutes, in one-minute intervals. If the MC75 is running on external power, set this period to 1, 2, 5, 10, 15, or 30 minutes. Check the Power window by selecting Start > Settings > System tab and tapping the Power icon. Select the Advanced tab and change the setting for a longer delay before the automatic shutoff feature activates.
	Battery is not inserted properly.	Insert the battery properly. See Installing the Main Battery on page 1-5 .
	Battery is depleted.	Replace the battery.
Tapping the window buttons or icons does not activate the corresponding feature.	Screen is not calibrated correctly.	Re-calibrate the screen. See Calibrating the Screen on page 1-8 .
	The system is not responding.	Warm boot the system. See Resetting the MC75 on page 1-8 .
A message appears stating that the MC75 memory is full.	Too many files stored on the MC75.	Delete unused memos and records. If necessary, save these records on the host computer (or use an SD card for additional memory).
	Too many applications installed on the MC75.	Remove user-installed applications on the MC75 to recover memory. Select Start > Settings > System tab and tap the Remove Programs icon. Select the unused program and tap Remove .
MC75 keeps powering down to protect memory contents.	The MC75's battery is low.	Recharge the battery.
	The internal Bluetooth radio is powered on for a long time.	Because this mode requires battery power, power it off when not needed. Using the SetDeviceState() API (refer to the <i>SMDK Help File</i>), set the Bluetooth to D4 power state.

Table 8-1 *Troubleshooting the MC75 (Continued)*

Problem	Cause	Solution
The MC75 does not accept scan input.	Scanning application is not loaded.	Load a scanning application on the MC75. See the system administrator.
	Unreadable bar code.	Ensure the symbol is not defaced.
	Distance between exit window and bar code is incorrect.	Place the MC75 within proper scanning range.
	MC75 is not programmed for the bar code.	Program the MC75 to accept the type of bar code being scanned.
	MC75 is not programmed to generate a beep.	If the MC75 does not beep on a good decode, set the application to generate a beep on good decode.
	Battery is low.	If the scanner stops emitting a laser beam upon a trigger press, check the battery level. When the battery is low, the scanner shuts off before the MC75 low battery condition notification. Note: If the scanner is still not reading symbols, contact the distributor or Symbol Technologies.
Cannot connect to service provider.	SIM not installed properly.	Re-install SIM card.

Bluetooth Connection

Table 8-2 *Troubleshooting Bluetooth Connection*

Problem	Cause	Solution
MC75 cannot find any Bluetooth devices nearby.	Too far from other Bluetooth devices.	Move closer to the other Bluetooth device(s), within a range of 10 meters.
	The Bluetooth device(s) nearby are not turned on.	Turn on the Bluetooth device(s) to find.
	The Bluetooth device(s) are not in discoverable mode.	Set the Bluetooth device(s) to discoverable mode. If needed, refer to the device's user documentation for help.
When trying to connect a Bluetooth phone and MC75, the phone thinks a previously paired MC75 is used.	The phone remembers the name and address of the MC75 it last paired with via the Bluetooth radio.	Manually delete the pairing device and name from the phone. Refer to the phone's user documentation for instructions.

Single Slot USB/Serial Cradle

Table 8-3 Troubleshooting the Single Slot USB/Serial Cradle

Symptom	Possible Cause	Action
LEDs do not light when MC75 or spare battery is inserted.	Cradle is not receiving power.	Ensure the power cable is connected securely to both the cradle and to AC power.
	MC75 is not seated firmly in the cradle.	Remove and re-insert the MC75 into the cradle, ensuring it is firmly seated.
	Spare battery is not seated firmly in the cradle.	Remove and re-insert the spare battery into the charging slot, ensuring it is firmly seated.
MC75 battery is not charging.	MC75 was removed from cradle or cradle was unplugged from AC power too soon.	Ensure cradle is receiving power. Ensure MC75 is seated correctly. Confirm main battery is charging under Start > Settings > System > Power . The 3600 mAh capacity battery fully charges in less than five hours.
	Battery is faulty.	Verify that other batteries charge properly. If so, replace the faulty battery.
	The MC75 is not fully seated in the cradle.	Remove and re-insert the MC75 into the cradle, ensuring it is firmly seated.
	Ambient temperature of the cradle is too warm.	Move the cradle to an area where the ambient temperature is between 0°C and 35°C.
Spare battery is not charging.	Battery not fully seated in charging slot.	Remove and re-insert the spare battery in the cradle, ensuring it is firmly seated.
	Battery inserted incorrectly.	Re-insert the battery so the charging contacts on the battery align with the contacts on the cradle.
	Battery is faulty.	Verify that other batteries charge properly. If so, replace the faulty battery.
	Ambient temperature of the cradle is too warm.	Move the cradle to an area where the ambient temperature is between 0°C and 35°C.
During data communication, no data transmits, or transmitted data was incomplete.	MC75 removed from cradle during communication.	Replace MC75 in cradle and retransmit.
	Incorrect cable configuration.	See the system administrator.
	Communication software is not installed or configured properly.	Perform setup as described in Chapter 3, ActiveSync .

Four Slot Ethernet Cradle

Table 8-4 Troubleshooting the Four Slot Ethernet Cradle

Symptom	Cause	Solution
Battery is not charging.	MC75 removed from the cradle too soon.	Replace the MC75 in the cradle. The 3600 mAh capacity battery fully charges in less than five hours. Tap Start > Settings > System > Power to view battery status.
	Battery is faulty.	Verify that other batteries charge properly. If so, replace the faulty battery.
	MC75 is not inserted correctly in the cradle.	Remove the MC75 and reinsert it correctly. Verify charging is active. Tap Start > Settings > System > Power to view battery status.
	Ambient temperature of the cradle is too warm.	Move the cradle to an area where the ambient temperature is between 0°C and 35°C.
During communication, no data was transmitted, or transmitted data was incomplete.	MC75 removed from cradle during communication.	Replace MC75 in cradle and retransmit.
	MC75 has no active connection.	An icon is visible in the status bar if a connection is active.

Vehicle Cradle

Table 8-5 Troubleshooting the Vehicle Cradle

Symptom	Possible Cause	Action
MC75 battery charging LED does not light up.	Cradle is not receiving power.	Ensure the power input cable is securely connected to the cradle's power port.
MC75 battery is not recharging.	MC75 was removed from the cradle too soon.	Replace the MC75 in the cradle. The 3600 mAh capacity battery fully charges in less than five hours.
	Battery is faulty.	Replace the battery.
	MC75 is not placed correctly in the cradle.	Remove the MC75 from the cradle, and re-insert correctly. If the battery still does not charge, contact customer support. The MC75 battery charging LED slowly blinks amber when the MC75 is correctly inserted and charging.
	Ambient temperature of the cradle is too warm.	Move to an area where the ambient temperature is between 0°C and 35°C.

Table 8-5 *Troubleshooting the Vehicle Cradle*

Symptom	Possible Cause	Action
No data transmitted, or transmitted data was incomplete.	MC75 removed from cradle during communication.	Replace MC75 in cradle and retransmit.
	No null modem cable was used.	Some external devices require a null modem cable. Retransmit using a null modem cable.
	Incorrect cable configuration.	See the system administrator.
	Cable missing or disconnected.	Re-connect cable.

Four Slot Spare Battery Charger

Table 8-6 *Troubleshooting the Four Slot Spare Battery Charger*

Symptom	Possible Cause	Action
Battery not charging.	Battery was removed from the charger or charger was unplugged from AC power too soon.	Re-insert the battery in the charger or re-connect the charger's power supply. The 3600 mAh capacity battery fully charges in less than five hours.
	Battery is faulty.	Verify that other batteries charge properly. If so, replace the faulty battery.
	Battery contacts not connected to charger.	Verify that the battery is seated in the battery well correctly with the contacts facing down.
	Ambient temperature of the cradle is too warm.	Move the cradle to an area where the ambient temperature is between 0°C and 35°C.

Cables

Table 8-7 *Troubleshooting the Cables*

Symptom	Possible Cause	Action
MC75 battery is not charging.	MC75 was disconnected from AC power too soon.	Connect the power cable correctly. Confirm main battery is charging under Start > Settings > System > Power . The 3600 mAh capacity battery fully charges in less than five hours.
	Battery is faulty.	Verify that other batteries charge properly. If so, replace the faulty battery.
	The MC75 is not fully attached to power.	Detach and re-attach the power cable to the MC75, ensuring it is firmly connected.

Table 8-7 Troubleshooting the Cables (Continued)

Symptom	Possible Cause	Action
During data communication, no data transmits, or transmitted data was incomplete.	Cable was disconnected from MC75 during communications.	Re-attach the cable and retransmit.
	Incorrect cable configuration.	See the system administrator.
	Communication software is not installed or configured properly.	Perform setup as described in <i>the Chapter 3, ActiveSync</i> .

Magnetic Stripe Reader

Table 8-8 Troubleshooting the Magnetic Stripe Reader

Symptom	Possible Cause	Action
MSR does not read card.	MSR removed from MC75 during card swipe.	Reattach MSR to MC75 and reswipe the card.
	Faulty magnetic stripe on card.	See the system administrator.
	MSR application is not installed or configured properly.	Ensure the MSR application is installed on the MC75. Ensure the MSR application is configured correctly.
MC75 battery is not charging.	MC75 was removed from MSR or MSR was unplugged from AC power too soon.	Ensure MSR is receiving power. Ensure MC75 is attached correctly. Confirm main battery is charging under Start > Settings > System > Power . The 3600 mAh capacity battery fully charges in less than five hours.
	Battery is faulty.	Verify that other batteries charge properly. If so, replace the faulty battery.
	The MC75 is not fully attached to the MSR.	Detach and re-attach the MSR to the MC75, ensuring it is firmly connected.
During data communication, no data transmits, or transmitted data was incomplete.	MC75 detached from MSR during communications.	Reattach MC75 to MSR and retransmit.
	Incorrect cable configuration.	See the system administrator.
	Communication software is not installed or configured properly.	Perform setup as described in <i>Chapter 3, ActiveSync</i> .

Appendix A Technical Specifications

Technical Specifications

The following tables summarize the intended operating environment and technical hardware specifications for the MC75 and accessories.

MC75

Table A-1 MC75 Technical Specifications

Item	Description
Physical Characteristics	
Dimensions	Length: 17.9 cm (7.06 in.) Width: 8.4 cm (3.30 in.) Depth: 4.4 cm (1.74 in.)
Weight (inc. standard battery)	422 grams (14.89 oz)
Display	Transflective color 3.5" VGA with backlight, TFT-LCD, 65K colors, 480 W x 640 L (VGA size)
Touch Panel	Glass analog resistive touch
Backlight	LED backlight
Main Battery	Rechargeable Lithium Ion 3.7V, 3600 mAh Smart Battery
Backup Battery	NiMH battery (rechargeable) 15 mAh 2.4V (not user-accessible)
Expansion Slot	User accessible microSD slot (with secure cover).
Network Connections	Ethernet (via cradle) High-speed USB, host or client, Bluetooth

Note 1: Total output power can be either USB or serial or a combination of both that cannot exceed 200 mA.

Table A-1 MC75 Technical Specifications (Continued)

Item	Description
Notification	Vibrator and audible alert
Keypad Options	26 key numeric, 26 key Direct Store Delivery (DSD) numeric 44 key QWERTY, 44 key AZERTY, 44 key QWERTZ
Audio	Speaker, receiver, microphone, headset jack, software support for full duplex record and playback (stereo)
Performance Characteristics	
CPU	Intel® XScale™ Bulverde PXA270 processor at 624MHz
Operating System	Microsoft® Windows Mobile™ 6
Memory	128MB RAM/256MB FLASH
Interface/Communications	RS-232, USB 1.1
Output Power (Note 1)	USB: 5 VDC @ 200 mA max. Serial: 5 VDC @ 200 mA max.
User Environment	
Operating Temperature	-10°C to 50°C (14°F to 122°F)
Storage Temperature	-20°C to 70°C (-4°F to 158°F)
Charging Temperature	32°F to 104°F / 0° C to 40° C
Humidity	95% non-condensing
Drop Specification	4 ft. drop to concrete, 6 drops per 6 sides over operating temperature range. 5 ft. drop to concrete, 2 drops per 6 sides at ambient temperature 23°C (73°F).
Electrostatic Discharge (ESD)	+/-15kVdc air discharge, +/-8kVdc direct discharge, +/-8kVdc indirect discharge
Sealing	IP54
Wireless WAN Data and Voice Communications	
Wireless Wide Area Network (WWAN) radios	MC7506 and MC7596: Tri-Band HSDPA (850, 1900 and 2100 MHz) Quad-Band Edge (850, 900, 1800 and 1900 MHz) MC7508 and MC7598: CDMA: EVDO Rev A (800 and 1900 MHz)
GPS	Integrated Assisted-GPS (A-GPS)
Wireless LAN Data and Voice Communications	
Wireless Local Area Network (WLAN) radio	Tri-mode IEEE® 802.11a/b/g
Data Rates Supported	1, 2, 5.5, 6, 9, 11, 12, 18, 24, 36, 48, and 54 Mbps

Note 1: Total output power can be either USB or serial or a combination of both that cannot exceed 200 mA.

Table A-1 MC75 Technical Specifications (Continued)

Item	Description
Operating Channels	Chan 8-169 (5040 – 5845 MHz) (4920 – 4980 MHz) Japan only Chan 1-13 (2412-2472 MHz) Chan 14 (2484 MHz) Japan only Actual operating frequencies depend on regulatory rules and certification agency
Security	WPA2, WPA, WEP (40 or 128 bit), TKIP, TLS, TTLS (MS-CHAP), TTLS (MS-CHAP v2), TTLS (CHAP), TTLS-MD5, TTLS-PAP, PEAP-TLS, PEAP (MS-CHAP v2), AES, LEAP
Spreading Technique	Direct Sequence Spread Spectrum (DSSS) and Orthogonal Frequency Division Multiplexing (OFDM)
Antenna	Internal for WLAN, Bluetooth and GPS, external for WWAN
Voice Communication	Integrated Voice-over-IP ready (P2P, PBX, PTT), Wi-Fi™-certified, IEEE 802.11a/b/g direct sequence wireless LAN
Wireless PAN Data and Voice Communications	
Bluetooth	Class II, v 2.0 EDR; on-board chip antenna.
Data Capture Specifications	
Options	2D imager, 1D linear, color camera
Linear 1D Scanner (SE950) Specifications	
Optical Resolution	0.005 in. minimum element width
Roll	+/- 30° from vertical
Pitch Angle	+/- 65° from normal
Skew Tolerance	+/- 60° from normal
Ambient Light	Sunlight: 8,000 ft. candles (86,112 Lux) Artificial Light: 450 ft. candles (4,844 Lux)
Shock	2,000 +/- 5% G
Scan Rate	50 (+/- 6) scans/sec (bidirectional)
Scan Angle	46.5° (typical)
Laser Power	1.0 mW nominal
2D Imager Engine (SE4400) Specifications	
Field of View	Horizontal - 32.2° Vertical - 24.5°
Optical Resolution	640 H x 480 V pixels (gray scale)
Roll	360°

Note 1: Total output power can be either USB or serial or a combination of both that cannot exceed 200 mA.

Table A-1 MC75 Technical Specifications (Continued)

Item	Description
Pitch Angle	+/- 60° from normal
Skew Tolerance	+/- 50° from normal
Ambient Light	Total darkness to 9,000 ft. candles (96,900 Lux)
Shock	2,000 +/- 5% G
Focal Distance from Front of Engine	Near: 5 inches Far: 9 inches
Aiming Element (VLD)	650 nm +/- 5 nm
Illumination Element (LED)	635 nm +/- 20 nm
Camera Specifications	
Resolution	2 Mega pixel with auto focus and flash

Note 1: Total output power can be either USB or serial or a combination of both that cannot exceed 200 mA.

MC75 COM Port Definitions

Table A-2 MC75 COM Port Definitions

COM Port	Definition
COM0	Available
COM1	Accessory port
COM2	Available
COM3	IRComm
COM4	Raw IrDA
COM5	BTVCOM
COM6	USBVCOM
BTS6	Bluetooth (Radio I/O)
COM7	Available
COM8	GPSId (GPSMux)
COM9	BTVCOM

MC75 Pin-Outs

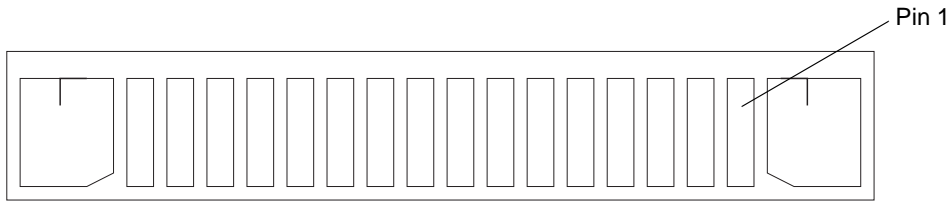

Figure A-1 External Connector

Table A-3 External Connector Pin-Outs

Pin	Description
1	Power Gnd
2	CRADLE_DETECT
3	RS232_DCD/TRIGGER
4	USB_D-
5	USB_D+
6	USB_Gnd
7	USB_Vbus
8	USB_ID
9	RS232_TXD
10	RS232_RXD
11	RS232_RTS
12	RS232_CTS
13	RS232_DTR
14	RS232_DSR
15	External_5.0V_Out
16	External DC In_5.4V

MC75 Accessory Specifications

Single Slot USB/Serial Cradle

Table A-4 *Single Slot USB/Serial Cradle Technical Specifications*

Feature	Description
Dimensions	Length: 14.54 cm (5.72 in.) Width: 11.05 cm (4.35 in.) Height: 9.10 cm (3.58 in.)
Weight	196 g (6.9 oz)
Input Power	12 VDC
Power Consumption	30 watts
Interface	USB, Serial
Operating Temperature	0°C to 50°C (32°F to 122°F)
Storage Temperature	-40°C to 70°C (-40°F to 158°F)
Charging Temperature	0°C to 40°C (32°F to 104°F)
Humidity	5% to 95% non-condensing
Drop	76.2 cm (30.0 in.) drops to vinyl tiled concrete at room temperature
Electrostatic Discharge (ESD)	+/- 15 kV air +/- 8 kV contact

Four Slot Ethernet Cradle

Table A-5 *Four Slot Ethernet Cradle Technical Specifications*

Feature	Description
Dimensions	Length: 46.78 cm (18.42 in.) Width: 11.00 cm (4.33 in.) Height: 13.70 cm (5.39 in.)
Weight	1079 g (2.38 lb)
Input Power	12 VDC
Power Consumption	100 watts
Interface	Ethernet
Operating Temperature	0°C to 50°C (32°F to 122°F)
Storage Temperature	-40°C to 70°C (-40°F to 158°F)

Table A-5 *Four Slot Ethernet Cradle Technical Specifications (Continued)*

Feature	Description
Charging Temperature	0°C to 40°C (32°F to 104°F)
Humidity	5% to 95% non-condensing
Drop	76.2 cm (30.0 in.) drops to vinyl tiled concrete at room temperature
Electrostatic Discharge (ESD)	+/- 15 kV air +/- 8 kV contact

Four Slot Charge Only Cradle

Table A-6 *Four Slot Charge Only Cradle Technical Specifications*

Feature	Description
Dimensions	Length: 46.78 cm (18.42 in.) Width: 11.00 cm (4.33 in.) Height: 13.70 cm (5.39 in.)
Weight	1079 g (2.38 lb)
Input Power	12 VDC
Power Consumption	100 watts
Operating Temperature	0°C to 50°C (32°F to 122°F)
Storage Temperature	-40°C to 70°C (-40°F to 158°F)
Charging Temperature	0°C to 40°C (32°F to 104°F)
Humidity	5% to 95% non-condensing
Drop	76.2 cm (30.0 in.) drops to vinyl tiled concrete at room temperature
Electrostatic Discharge (ESD)	+/- 15 kV air +/- 8 kV contact

Four Slot Battery Charger

Table A-7 *Four Slot Battery Charger Technical Specifications*

Feature	Description
Dimensions	Length: 21.00 cm (8.27 in.) Width: 15.50 cm (6.10 in.) Height: 3.47 cm (1.37 in.)
Weight	386 g (13.6 oz)
Input Power	12 VDC

Table A-7 Four Slot Battery Charger Technical Specifications (Continued)

Feature	Description
Power Consumption	30 watts
Operating Temperature	0°C to 50°C (32°F to 122°F)
Storage Temperature	-40°C to 70°C (-40°F to 158°F)
Charging Temperature	0°C to 40°C (32°F to 104°F)
Humidity	5% to 95% non-condensing
Drop	76.2 cm (30.0 in.) drops to vinyl tiled concrete at room temperature
Electrostatic Discharge (ESD)	+/- 15 kV air +/- 8 kV contact

Magnetic Stripe Reader

Table A-8 Magnetic Stripe Reader (MSR) Technical Specifications

Feature	Description
Dimensions	Length: 7.87 cm (3.1 in.) Width: 8.38 cm (3.3 in.) Height: 3.56 cm (1.4 in.)
Weight	48 g (1.7 oz)
Interface	Serial with baud rate up to 19,200
Format	ANSI, ISO, AAMVA, CA DMV, user-configurable generic format
Swipe Speed	5 to 50 in. (127 to 1270 mm) /sec, bi-directional
Decoders	Generic, Raw Data
Mode	Buffered, unbuffered
Track Reading Capabilities	Tracks 1 and 3: 210 bpi Track 2: 75 and 210 bpi, autodetect
Operating Temperature	0°C to 50°C (32°F to 122°F)
Storage Temperature	-40°C to 70°C (-40°F to 158°F)
Humidity	5% to 95% non-condensing
Drop	1.22 m (4 ft.) drops to concrete
Electrostatic Discharge (ESD)	+/- 15 kV air +/- 8 kV contact

Vehicle Cradle

Table A-9 *Vehicle Cradle Technical Specifications*

Feature	Description
Dimensions	Length: 11.00 cm (4.33 in.) Width: 9.50 cm (3.74 in.) Height: 20.50 cm (8.07 in.)
Weight	567 g (20 oz)
Input Power	12/24 VDC
Power Consumption	25 watts
Operating Temperature	0°C to 50°C (32°F to 122°F)
Storage Temperature	-40°C to 70°C (-40°F to 158°F)
Charging Temperature	0°C to 40°C (32°F to 104°F)
Humidity	10% to 95% non-condensing
Drop	76.2 cm (30.0 in.) drops to vinyl tiled concrete at room temperature
Electrostatic Discharge (ESD)	+/- 15 kV air +/- 8 kV contact

Appendix B Bluetooth Configuration

The MC75 supports both the Microsoft Bluetooth stack and the StoneStreet One Bluetooth stack. Only one Bluetooth stack can be used at a time. By default, the StoneStreet One Bluetooth stack is enabled. A registry key on the MC75 can be modified to disable the StoneStreet One stack and enable the Microsoft stack.

Using a registry editor, navigate to the following:

```
[HKEY_LOCAL_MACHINE\Software\SymbolBluetooth
```

Edit the following key:

```
"SSStack"=dword:1
```

where:

0 = disable StoneStreet One stack and enable Microsoft stack

1 = enable StoneStreet One stack and disable Microsoft stack (default)

After setting the registry key, warm boot the MC75.

Glossary

A

ActiveSync. ActiveSync is a data synchronization program developed by Microsoft for use with Windows Mobile operating systems.

AFH. Adaptive Frequency Hopping

AKU. (Adaptation Kit Update) Updates to the Windows Mobile operating system.

API. (Application Programming Interface) An interface by means of which one software component communicates with or controls another. Usually used to refer to services provided by one software component to another, usually via software interrupts or function calls

ASCII. American Standard Code for Information Interchange. A 7 bit-plus-parity code representing 128 letters, numerals, punctuation marks and control characters. It is a standard data transmission code in the U.S.

AZERTY. A standard keyboard commonly used on French keyboards. "AZERTY" refers to the arrangement of keys on the top row of keys.

B

Bar Code. A pattern of variable-width bars and spaces which represents numeric or alphanumeric data in machine-readable form. The general format of a bar code symbol consists of a leading margin, start character, data or message character, check character (if any), stop character, and trailing margin. Within this framework, each recognizable symbology uses its own unique format. See **Symbology**.

Bit. Binary digit. One bit is the basic unit of binary information. Generally, eight consecutive bits compose one byte of data. The pattern of 0 and 1 values within the byte determines its meaning.

Bits per Second (bps). Bits transmitted or received.

Bluetooth. A wireless protocol utilizing short-range communications technology facilitating data transmission over short distances.

boot or boot-up. The process a computer goes through when it starts. During boot-up, the computer can run self-diagnostic tests and configure hardware and software.

bps. See **Bits Per Second**.

Byte. On an addressable boundary, eight adjacent binary digits (0 and 1) combined in a pattern to represent a specific character or numeric value. Bits are numbered from the right, 0 through 7, with bit 0 the low-order bit. One byte in memory is used to store one ASCII character.

C

CDRH. Center for Devices and Radiological Health. A federal agency responsible for regulating laser product safety. This agency specifies various laser operation classes based on power output during operation.

CDRH Class 1. This is the lowest power CDRH laser classification. This class is considered intrinsically safe, even if all laser output were directed into the eye's pupil. There are no special operating procedures for this class.

CDRH Class 2. No additional software mechanisms are needed to conform to this limit. Laser operation in this class poses no danger for unintentional direct human exposure.

Character. A pattern of bars and spaces which either directly represents data or indicates a control function, such as a number, letter, punctuation mark, or communications control contained in a message.

Codabar. A discrete self-checking code with a character set consisting of digits 0 to 9 and six additional characters: ("-", "\$", ":", "/", ",", "+").

Code 128. A high density symbology which allows the controller to encode all 128 ASCII characters without adding extra symbol elements.

Code 3 of 9 (Code 39). A versatile and widely used alphanumeric bar code symbology with a set of 43 character types, including all uppercase letters, numerals from 0 to 9 and 7 special characters ("-", ".", "/", "+", "%", "\$" and space). The code name is derived from the fact that 3 of 9 elements representing a character are wide, while the remaining 6 are narrow.

Code 93. An industrial symbology compatible with Code 39 but offering a full character ASCII set and a higher coding density than Code 39.

Cold Boot. A cold boot restarts the mobile computer and initializes some drivers.

COM port. Communication port; ports are identified by number, e.g., COM1, COM2.

Cradle. A cradle is used for charging the terminal battery and for communicating with a host computer, and provides a storage place for the terminal when not in use.

D

DCP. See **Device Configuration Package**.

Decode. To recognize a bar code symbology (e.g., UPC/EAN) and then analyze the content of the specific bar code scanned.

Decode Algorithm. A decoding scheme that converts pulse widths into data representation of the letters or numbers encoded within a bar code symbol.

Depth of Field. The range between minimum and maximum distances at which a scanner can read a symbol with a certain minimum element width.

Device Configuration Package. The Device Configuration Package provides the flash partitions, Terminal Configuration Manager (TCM) and the associated TCM scripts. With this package hex images that represent flash partitions can be created and downloaded to the mobile computer.

Discrete 2 of 5. A binary bar code symbology representing each character by a group of five bars, two of which are wide. The location of wide bars in the group determines which character is encoded; spaces are insignificant. Only numeric characters (0 to 9) and START/STOP characters may be encoded.

E

EAN. European Article Number. This European/International version of the UPC provides its own coding format and symbology standards. Element dimensions are specified metrically. EAN is used primarily in retail.

EMDK. Enterprise Mobility Developer's Kit.

ESD. Electro-Static Discharge

F

FHSS (Frequency Hopping Spread Spectrum). A method of transmitting radio signals by rapidly switching a carrier among many frequency channels, using a pseudorandom sequence known to both transmitter and receiver.

File Transfer Protocol (FTP). A TCP/IP application protocol governing file transfer via network or telephone lines. See **TCP/IP**.

Flash Memory. Flash memory is nonvolatile, semi-permanent storage that can be electronically erased in the circuit and reprogrammed.

H

Hard Reset. See **Cold Boot**.

Hz. Hertz; A unit of frequency equal to one cycle per second.

Host Computer. A computer that serves other terminals in a network, providing such services as computation, database access, supervisory programs and network control.

I

IDE. Intelligent drive electronics. Refers to the solid-state hard drive type.

IEC. International Electrotechnical Commission. This international agency regulates laser safety by specifying various laser operation classes based on power output during operation.

IEC (825) Class 1. This is the lowest power IEC laser classification. Conformity is ensured through a software restriction of 120 seconds of laser operation within any 1000 second window and an automatic laser shutdown if the scanner's oscillating mirror fails.

IEEE Address. See **MAC Address**.

Input/Output Ports. I/O ports are primarily dedicated to passing information into or out of the terminal's memory. Series 9000 mobile computers include Serial and USB ports.

Interleaved 2 of 5. A binary bar code symbology representing character pairs in groups of five bars and five interleaved spaces. Interleaving provides for greater information density. The location of wide elements (bar/spaces) within each group determines which characters are encoded. This continuous code type uses no intercharacter spaces. Only numeric (0 to 9) and START/STOP characters may be encoded.

Internet Protocol Address. See **IP**.

I/O Ports. interface The connection between two devices, defined by common physical characteristics, signal characteristics, and signal meanings. Types of interfaces include RS-232 and PCMCIA.

IP. Internet Protocol. The IP part of the TCP/IP communications protocol. IP implements the network layer (layer 3) of the protocol, which contains a network address and is used to route a message to a different network or subnetwork. IP accepts "packets" from the layer 4 transport protocol (TCP or UDP), adds its own header to it and delivers a "datagram" to the layer 2 data link protocol. It may also break the packet into fragments to support the maximum transmission unit (MTU) of the network.

IP Address. (Internet Protocol address) The address of a computer attached to an IP network. Every client and server station must have a unique IP address. A 32-bit address used by a computer on a IP network. Client workstations have either a permanent address or one that is dynamically assigned to them each session. IP addresses are written as four sets of numbers separated by periods; for example, 204.171.64.2.

IPX/SPX. Internet Package Exchange/Sequential Packet Exchange. A communications protocol for Novell. IPX is Novell's Layer 3 protocol, similar to XNS and IP, and used in NetWare networks. SPX is Novell's version of the Xerox SPP protocol.

ISM. Industry Scientific and Medical

K

Key. A key is the specific code used by the algorithm to encrypt or decrypt the data. Also see, **Encryption** and **Decrypting**.

L

LASER. Light Amplification by Stimulated Emission of Radiation. The laser is an intense light source. Light from a laser is all the same frequency, unlike the output of an incandescent bulb. Laser light is typically coherent and has a high energy density.

laser scanner. A type of bar code reader that uses a beam of laser light.

LCD. See **Liquid Crystal Display**.

LED Indicator. A semiconductor diode (LED - Light Emitting Diode) used as an indicator, often in digital displays. The semiconductor uses applied voltage to produce light of a certain frequency determined by the semiconductor's particular chemical composition.

Light Emitting Diode. See **LED**.

Liquid Crystal Display (LCD). A display that uses liquid crystal sealed between two glass plates. The crystals are excited by precise electrical charges, causing them to reflect light outside according to their bias. They use little electricity and react relatively quickly. They require external light to reflect their information to the user.

M

MC. Mobile Computer.

MDN. Mobile Directory Number. The directory listing telephone number that is dialed (generally using POTS) to reach a mobile unit. The MDN is usually associated with a MIN in a cellular telephone -- in the US and Canada, the MDN and MIN are the same value for voice cellular users. International roaming considerations often result in the MDN being different from the MIN.

MIN. Mobile Identification Number. The unique account number associated with a cellular device. It is broadcast by the cellular device when accessing the cellular system.

Mobile Computer. In this text, *mobile computer* refers to the MC75 wireless computer. It can be set up to run as a stand-alone device, or it can be set up to communicate with a network, using wireless radio technology.

N

Nominal. The exact (or ideal) intended value for a specified parameter. Tolerances are specified as positive and negative deviations from this value.

NVM. Non-Volatile Memory.

O

Open System Authentication. Open System authentication is a null authentication algorithm.

P

PAN. Personal area network. Using Bluetooth wireless technology, PANs enable devices to communicate wirelessly. Generally, a wireless PAN consists of a dynamic group of less than 255 devices that communicate within about a 33-foot range. Only devices within this limited area typically participate in the network.

PING. (Packet Internet Groper) An Internet utility used to determine whether a particular IP address is online. It is used to test and debug a network by sending out a packet and waiting for a response.

Q

QWERTY. A standard keyboard commonly used on North American and some European keyboards. "QWERTY" refers to the arrangement of keys on the top row of keys.

QWERTZ. A standard keyboard commonly used on German keyboards. "QWERTZ" refers to the arrangement of keys on the top row of keys.

R

RAM. Random Access Memory. Data in RAM can be accessed in random order, and quickly written and read.

RF. Radio Frequency.

ROM. Read-Only Memory. Data stored in ROM cannot be changed or removed.

Router. A device that connects networks and supports the required protocols for packet filtering. Routers are typically used to extend the range of cabling and to organize the topology of a network into subnets. See **Subnet**.

RS-232. An Electronic Industries Association (EIA) standard that defines the connector, connector pins, and signals used to transfer data serially from one device to another.

S

Scanner. An electronic device used to scan bar code symbols and produce a digitized pattern that corresponds to the bars and spaces of the symbol. Its three main components are: 1) Light source (laser or photoelectric cell) - illuminates a bar code; 2) Photodetector - registers the difference in reflected light (more light reflected from spaces); 3) Signal conditioning circuit - transforms optical detector output into a digitized bar pattern.

SDK. Software Development Kit

Shared Key. Shared Key authentication is an algorithm where both the AP and the MU share an authentication key.

Soft Reset. See **Warm Boot**.

Space. The lighter element of a bar code formed by the background between bars.

Specular Reflection. The mirror-like direct reflection of light from a surface, which can cause difficulty decoding a bar code.

Start/Stop Character. A pattern of bars and spaces that provides the scanner with start and stop reading instructions and scanning direction. The start and stop characters are normally to the left and right margins of a horizontal code.

Subnet. A subset of nodes on a network that are serviced by the same router. See **Router**.

Subnet Mask. A 32-bit number used to separate the network and host sections of an IP address. A custom subnet mask subdivides an IP network into smaller subsections. The mask is a binary pattern that is matched up with the IP address to turn part of the host ID address field into a field for subnets. Default is often 255.255.255.0.

Substrate. A foundation material on which a substance or image is placed.

Symbol. A scannable unit that encodes data within the conventions of a certain symbology, usually including start/stop characters, quiet zones, data characters and check characters.

Symbol Aspect Ratio. The ratio of symbol height to symbol width.

Symbol Height. The distance between the outside edges of the quiet zones of the first row and the last row.

Symbol Length. Length of symbol measured from the beginning of the quiet zone (margin) adjacent to the start character to the end of the quiet zone (margin) adjacent to a stop character.

Symbology. The structural rules and conventions for representing data within a particular bar code type (e.g. UPC/EAN, Code 39, PDF417, etc.).

T

TCP/IP. (Transmission Control Protocol/Internet Protocol) A communications protocol used to internetwork dissimilar systems. This standard is the protocol of the Internet and has become the global standard for communications. TCP provides transport functions, which ensures that the total amount of bytes sent is received correctly at the other end. UDP is an alternate transport that does not guarantee delivery. It is widely used for real-time voice and video transmissions where erroneous packets are not retransmitted. IP provides the routing mechanism. TCP/IP is a routable protocol, which means that all messages contain not only the address of the destination station, but the address of a destination network. This allows TCP/IP messages to be sent to multiple networks within an organization or around the world, hence its use in the worldwide Internet. Every client and server in a TCP/IP network requires an IP address, which is either permanently assigned or dynamically assigned at startup.

Telnet. A terminal emulation protocol commonly used on the Internet and TCP/IP-based networks. It allows a user at a terminal or computer to log onto a remote device and run a program.

Terminal. See **Mobile Computer**.

Terminal Emulation. A “terminal emulation” emulates a character-based mainframe session on a remote non-mainframe terminal, including all display features, commands and function keys. The VC5000 Series supports Terminal Emulations in 3270, 5250 and VT220.

TFTP. (Trivial File Transfer Protocol) A version of the TCP/IP FTP (File Transfer Protocol) protocol that has no directory or password capability. It is the protocol used for upgrading firmware, downloading software and remote booting of diskless devices.

Tolerance. Allowable deviation from the nominal bar or space width.

Transmission Control Protocol/Internet Protocol. See **TCP/IP**.

Trivial File Transfer Protocol. See **TFTP**.

U

UDP. User Datagram Protocol. A protocol within the IP protocol suite that is used in place of TCP when a reliable delivery is not required. For example, UDP is used for real-time audio and video traffic where lost packets are simply ignored, because there is no time to retransmit. If UDP is used and a reliable delivery is required, packet sequence checking and error notification must be written into the applications.

UPC. Universal Product Code. A relatively complex numeric symbology. Each character consists of two bars and two spaces, each of which is any of four widths. The standard symbology for retail food packages in the United States.

V

Visible Laser Diode (VLD). A solid state device which produces visible laser light.

W

Warm Boot. A warm boot restarts the mobile computer by closing all running programs. All data that is not saved to flash memory is lost.

Index

A

accessories	1-2
auto charge cable	1-2
cables	1-2, 2-36
communication/charge cables	2-36
battery charging	2-37
LED indicators	2-37
DEX cable	1-2
EMDK	1-3
four slot Ethernet cradle	1-2, 2-1, 2-5
four slot spare battery charger	1-2, 2-1
headset	1-3, 2-1, 2-34
holster	1-3
magnetic stripe reader	1-2
MMC	1-10, 2-34
modem cable	1-2
modem inverter cable	1-2
mounting bracket	2-11
MSR	1-2, 2-23
installation	2-23
magnetic stripe reading	2-23
O'Neil printer cable	1-2
rigid holster	2-1
SD card	2-34
SIM card	1-4
single slot USB serial cradle	2-1, 2-2
spare battery	1-3
specifications	A-6
stylus	1-3
USB charger cable	1-2
USB cradle	1-2
vehicle cradle	1-2, 2-1, 2-13
wall mounting kit, cradle	1-3
Zebra printer cable	1-2
zebra printer cable	1-2
activation	

CDMA	6-5
Sprint CDMA	6-3
Verizon CDMA	6-2
ActiveSync	3-1
deploying CAB files	4-4
installing	3-1
setting up a connection	3-3
AirBEAM	
deploying CAB files	4-5
APN	5-4
application deployment	4-1, 4-4
CAB files	4-4
application folder	4-9
application packaging	4-4
application security	4-1
auto charge cable	1-2

B

backup battery	
charging	1-6
battery	
charging	1-6
check status	1-8
installing	1-5
removing	1-12
battery chargers	
communication/charge cables	2-36
battery charging	2-37
LED indicators	2-37
battery charging	1-6
communication/charge cables	2-37
battery charging	2-37
four slot Ethernet cradle	2-8
single slot cradle	2-2
spare	2-21
vehicle cradle	2-17

bluetooth
 troubleshooting 8-7

boot
 clean 1-9
 cold 1-8
 warm 1-8

bullets xviii

C

CAB files 4-4, 4-7, 4-10
 deployment via ActiveSync 4-4
 deployment via AirBEAM 4-5
 deployment via image update 4-5
 deployment via storage card 4-4

cables 1-2, 2-36
 auto charge cable 1-2
 charging 2-36
 communication 2-36
 communication setup 2-37
 DEX cable 1-2
 modem 1-2
 pinouts A-5
 setup 2-36
 troubleshooting 8-10
 USB charger 1-2

cache disk 4-9

calibrating the screen 1-8

call barring 6-14

call blocking See call barring 5-10

call forwarding 5-11, 6-14

call waiting 5-12, 6-15

caller id 5-11, 6-14

CDMA
 activate Sprint 6-3
 activate Verizon 6-2
 activate Verizon automated 6-2
 data connection 6-6
 settings
 data, Sprint 6-8
 data, Verizon 6-10
 location 6-8
 phone 6-7
 phone info 6-13
 provisioning 6-9
 services 6-14, 6-15
 system, Sprint 6-11
 system, Verizon 6-12, 6-13
 test activation 6-5

certificates 4-3

changing a PIN for phone use 5-9

charging
 communication/charge cables 2-37
 four slot Ethernet cradle 2-8

 single slot cradle 2-2
 spare batteries 1-7, 2-21
 vehicle cradle 2-17

charging temperature 1-7

clean boot 1-9

cleaning 8-1

cold boot 1-8

communication
 charge cables 2-36

communication setup
 communication/charge cables 2-37

communication/charge cables
 battery charging 2-37
 communication setup 2-37
 LED indicators 2-37

configuration xiv, 1-3

conventions
 notational xvii

copyfile 4-8

cpf file 4-7, 4-10

cradles
 daisy chaining 2-5
 Ethernet drivers 2-6
 four slot Ethernet 1-2, 2-1, 2-5
 charging 2-8
 charging indicators 2-9
 setup 2-5, 2-10
 four slot spare battery charger 2-1
 charging 2-21
 charging indicators 2-22
 setup 2-21
 mounting bracket 2-11
 single slot USB serial 2-1, 2-2
 charging indicators 2-3
 setup 2-2
 troubleshooting 8-8, 8-9, 8-10
 vehicle 1-2, 2-1, 2-13
 charging 2-17
 charging indicators 2-19
 setup 2-14

creating cpf file 4-7
 SCM 4-10

creating splash screen 4-6

D

data capture xiv

data connection 5-4, 6-6

deployment 4-1, 4-4
 CAB files 4-4
 file 4-12

DEX cable 1-2

digital signatures 4-1

disabling PIN for phone use 5-9

disconnecting 5-7
display xiv

E

EDA configuration 1-3
EMDK xviii, 4-12
enabling PIN for phone use 5-9
enhanced operator name string 5-17
Enterprise Mobility Developer Kit xviii, 4-12
enterprise mobility developer kit 1-3
EONS 5-17
ESD 1-11
Ethernet cradle 1-2, 2-1

F

file deployment 4-12
flash file system
 copyfile 4-8
 regmerge 4-7
four slot Ethernet cradle 2-5
 charging 2-8
 charging indicators 2-9
 daisy chaining 2-5
 drivers 2-6
 link indicator 2-9
 setup 2-5, 2-10
 speed indicator 2-9
 troubleshooting 8-9
four slot spare battery charger 1-2, 2-1
 charging 2-21
 charging indicators 2-22
 setup 2-21
 shim installation 2-21
 troubleshooting 8-10

G

GPRS
 data connection 5-2, 5-4, 5-5
 data disconnect 5-7
 registry file 5-4
 settings
 services 6-14
 WAN configuration 5-4
GSM
 access point name 5-4
 configure GPRS data connection 5-2, 5-4
 ensuring network coverage 5-2, 5-3
 GPRS data connection 5-5
 settings
 networks 5-13
 phone 5-8

phone info 5-16
PIN 5-9
security 5-9
services 5-10, 5-11, 5-12
sound 5-8

H

hard reset 1-8, 1-9
headset 1-3, 2-1, 2-34
holster 1-3

I

image update
 deploying CAB files 4-5
information, service xviii
installing battery 1-5
internet
 disconnecting GPRS 5-7
 via GPRS 5-5
 wireless connection 5-4, 6-6

K

keypads xiv

L

lithium-ion battery 1-1
locking EDA 1-10, 4-2

M

magnetic stripe reader 1-2, 2-23
 installation 2-23
 magnetic stripe reading 2-23
 troubleshooting 8-11
main battery
 charging 1-3, 1-6, 6-1
 installing 1-3, 6-1
maintenance 8-1
memory xiv
MMC 1-10, 2-34
modem cable 1-2
Monarch printer cable 2-36
mounting bracket 2-11
MSR 1-2, 2-23
 installation 2-23
 magnetic stripe reading 2-23
 troubleshooting 8-11
multi media card 1-10, 2-34

N

network
 configuring GPRS WAN 5-4
 GSM 5-13
 network coverage, GSM 5-2, 5-3

O

O'Neil printer cable 2-36
 operating environment A-1
 operating systemxiv

P

packaging 4-4
 persistent storage 4-9
 phone
 activation 6-2, 6-3
 phone activation 6-5
 phone security 5-9
 phone settings 5-8
 PIN, changing for phone 5-9
 PIN, disabling for phone use 5-9
 PIN, enabling for phone use 5-9
 pinouts A-5
 powering on EDA 1-8
 provisioning 6-9

R

radiosxiv
 RAM 4-9
 random access memory 4-9
 RAPI 4-3
 regmerge 4-7
 remote API 4-3
 removing main battery 1-12
 reset
 hard 1-8, 1-9
 soft 1-8
 rigid holster 1-3, 2-1
 RS232 charge cable 2-36

S

SCM 4-9
 file deployment 4-12
 file types 4-10
 menu 4-10
 parameter indicators 4-11
 user interface 4-10
 XML provisioning 4-10
 screen

 calibration 1-8
 splash window 1-8
 SD 2-34
 SDK
 See EMDK 1-3
 secure digital card 2-34
 security 4-1
 application 4-1
 certificates 4-3
 device management 4-3
 digital signatures 4-1
 locking device 4-2
 remote API 4-3
 serial charge cable 2-36
 service informationxviii
 service provider name display 5-17
 services, CDMA
 call barring 6-14
 call forwarding 6-14
 call waiting 6-15
 caller id 6-14
 SMS 6-15
 voice mail 6-15
 services, GSM
 call barring 5-10
 call forwarding 5-11
 call waiting 5-12
 caller id 5-11
 text messages 5-12
 voice mail 5-12
 settings
 CDMA 6-1, 6-7
 GSM 5-2
 GSM/GPRS 5-8
 shim installation 2-21
 short message service 6-15
 SIM card
 accessories 1-4
 activation 5-3
 install 1-4
 network access 5-13
 single slot USB serial cradle 2-2
 charging 2-2
 charging indicators 2-3
 troubleshooting 8-8
 SMS 6-15
 soft reset 1-8
 spare battery 1-3
 charging 1-7
 spare battery charger 2-1
 charging 2-21
 charging indicators 2-22
 setup 2-21
 splash screen

- creating 4-6
- Sprint phone activation 6-3
- starting EDA 1-3, 1-8
- starting the mobile computer 6-1
- storage 4-8
 - application folder 4-9
 - cache disk 4-9
 - persistent 4-9
 - volatile 4-9
- storage card
 - deploying CAB files 4-4
- strap 1-1
- stylus 1-1, 1-3
- subscriber identification module 1-4
- suspend 1-12
- Symbol configuration manager 4-9
 - file deployment 4-12
 - file types 4-10
 - menu 4-10
 - parameter indicators 4-11
 - user interface 4-10
 - XML provisioning 4-10

T

- technical specifications A-1
 - accessories A-6
- temperature A-2
 - charging 1-7
- text messages 5-12
- troubleshooting 8-5
 - bluetooth 8-7
 - cables 8-10
 - EDA 8-5
 - four slot Ethernet cradle 8-9
 - four slot spare battery charger 8-10
 - MSR 8-11
 - single slot USB serial cradle 8-8
 - vehicle cradle 8-9

U

- unpacking 1-1
- USB charger 1-2
- USB client charge cable 2-36
- USB cradle 1-2

V

- vehicle cradle 1-2, 2-1, 2-13
 - charging indicators 2-19
 - troubleshooting 8-9
- Verizon phone activation 6-2
- voice mail 5-12, 6-15

- volatile storage 4-9

W

- wakeup conditions 1-9
- waking EDA 1-9
- wall mount bracket 2-11
- wall mounting kit, cradle 1-3
- warm boot 1-8
- wireless
 - internet 5-4, 6-6
- WLAN 802.11a/b/g xiv
- WPAN Bluetooth xiv
- WWAN
 - configuring GPRS 5-4

X

- XML provisioning 4-6, 4-7
 - certificates 4-3
 - SCM 4-10

Z

- Zebra printer cable 2-36



MOTOROLA

Motorola, Inc.
One Motorola Plaza
Holtsville, New York 11742, USA
1-800-927-9626
<http://www.motorola.com/enterprisemobility>

MOTOROLA and the Stylized M Logo and Symbol and the Symbol logo are registered in the U.S. Patent and Trademark Office.
All other product or service names are the property of their registered owners.
© Motorola, Inc. 2008-10